

\$ 19.95

THE SHOP BUILT 30 CAL AIR MACHINE GUN

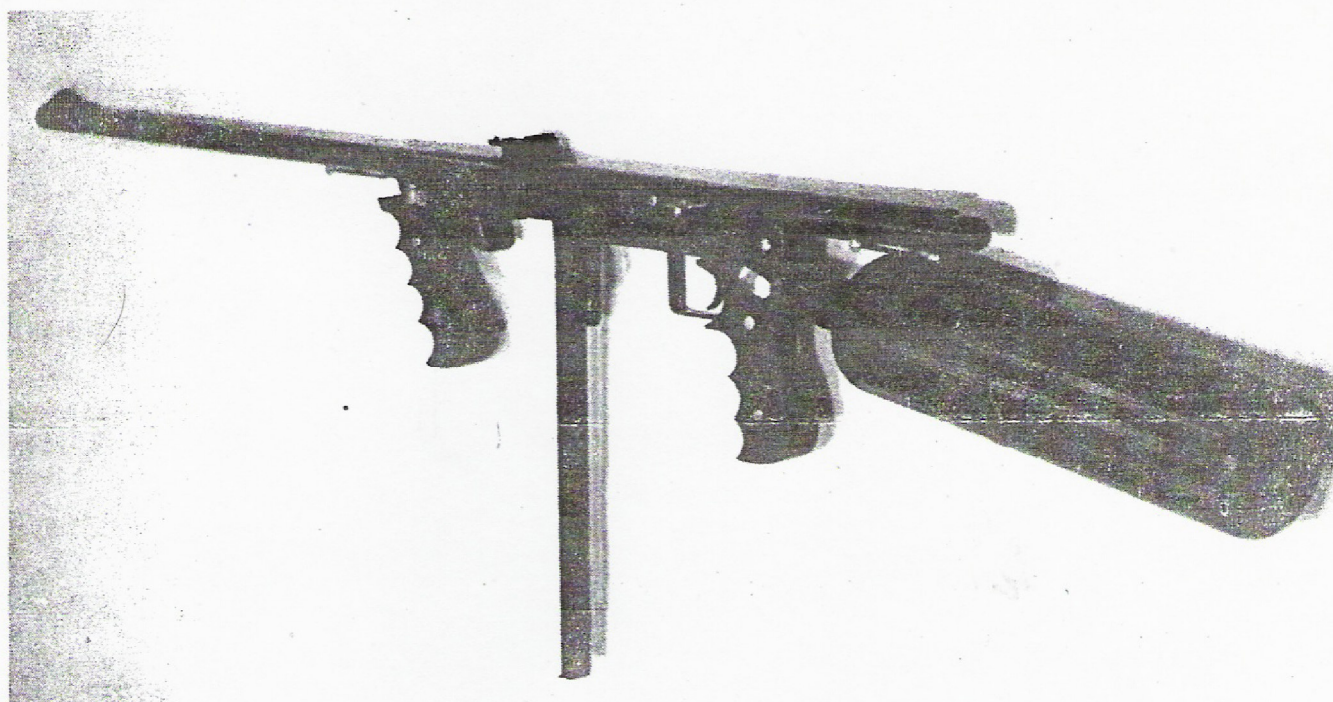

SELF SUFFICIENT

DELIVERS 32 ACP POWER

DESIGN - HAND HELD SELECTIVE FIRE AUTOMATIC

SYSTEM OF OPERATION - BLOW BACK

CALIBER - 30 (.311 BOTTOM GROOVE)

BARREL LENGTH - 20" to 24"

MAGAZINE CAPACITY - 30 BULLETS (85 to 100 gr.)

OVERALL LENGTH - APPROX. 45"

WEIGHT - 10 to 12 LBS.

BY CASELMAN EXPLORATIONS

THE 30 CAL. AIR MACHINE GUN
Copyright 1990 by Caselman Explorations
Printed in the United States of America

All rights reserved. No portion of this book may be reproduced in any form without the express written permission from Caselman Explorations. Direct all inquiries and or orders to the address listed below.

Caselman Explorations
P.O. Box 348
Cameron, Mo. 64429



Caselman Explorations assumes no responsibility for the use or misuse of the information contained in this book.

FOWARD

I started working on the concept of a high powered pneumatic rifle in 1979. (Although the idea started cooking as a young boy.) I started with a small lathe and just a few tools, located on a back porch shop. I've made a lot of progress, with added tooling, and a better place to work, but it has been slow going, as I had to make a living to support my family, build up my tools, and be creative with virtually no money to spend on the project. The break-through is finally here, and after several prototypes, I have something to share and hopefully in time to beat gun prohibition and share these plans with you.

With the gun prohibition staring us in the face...it's nice to know you don't have to be without protection. This gun was designed with the idea that any and all guns could be banned. Ammo could also become illegal or unavailable. That's why we strongly urge you to save these plans. Having the security of knowing you can make a high-powered automatic with high pressure air, and mold your own bullets.

This weapon was developed as a self-sufficeint, pneumatic alternative for home protection & defense, and also inexpensive machine gun shooting and enjoyment. It can be extremely powerful for 30 shots, or tuned down to 150 shots for shooting pleasure.

This alternative weapon can be built on a lathe with a milling attachment with basic shop tools.

If extreme pressure is to be used with this gun, specific steels professional workmanship and tank selection are of the utmost importance.

Improper handeling, or construction of this weapon can be dangerous. Caution should always be applied as with any powerful gun. Keep in mind a modern high pressure gun such as a 30-06 develops 50,000 lbs. of pressure on firing, if improperly handled is extremely dangerous also.

This weapon was individually handmade, although any and all parts may be ordered at an hourly shop rate from; Caselman Explorations, P.O. Box 348, Cameron, Mo. 64429

PARTS LIST

CR-Cold Roll Steel
MW-Music Wire
01-Oil Harden Tool Steel

1. Firing Valve-CR
2. Firing Valve Stem-Dowel Pin
3. Firing Valve Seat-Ultra high density plastic
4. Firing Valve Body-CR
5. Firing Valve Holding Area-CR
6. Firing Valve Spring-MW
7. Firing Valve Spring Guide-22 ga. CR
8. Firing Valve O Ring
9. Striker-01 or CR
10. Cocking Pin-Concrete Nail etc.
11. Cocking Pin Retaining Roll Pin
12. Striker Screws 6-32
13. Striker Follower-D.O.M. Mechanical Tube
14. Striker Follower Sear-01
15. Striker Spring-MW
16. Striker Buffer-Plastic
17. Bolt-01 or CR
18. Bolt Body-D.O.M. Mechanical Tube
19. Bolt O Ring-5/16 by 3/16 by 1/16
20. Bolt Pins-3/32 Roll Pins 1/2 long
21. Bolt Spring-MW
22. Spring Follower-CR
23. Breech Plug-CR
24. Breech Plug Screw-1/4 28
25. Receiver-D.O.M. Mechanical Tube
26. Barrel-Select 311 Bottom Groove
27. Barrel Screw-1/4 28
28. Trigger Housing-1 by 1 1/8 by 1/8 Rectangular Tube
29. Trigger Housing Mounting Block Rear-CR
30. Trigger Housing Mounting Block Front-CR
31. Trigger Housing Screws-10-32
32. Trigger Guard-CR
33. Trigger-CR
34. Trigger Frame Block-CR
35. Trigger Stop Screw Adjust-10-32 by 1/2
36. Trigger Stop Screw Setnut-10-32
37. Trigger Pivot Pin-Dowel Pin 1/8 by 1
38. E-Clip Spacers
39. Trigger Spring-Torsion-MW
40. Full Auto Sear Trip-01
41. Full Auto Sear Trip Pin-Dowel Pin 1/8 by 5/8
42. Full Auto Sear Trip Spacer-CR
43. Sear Spring-MW
44. Disconnecter-01
45. Sear-01
46. Sear Spring-MW
47. Sear Stop Screw & Set Nuts-6-32
48. Magazine Housing-CR
49. Magazine Release-CR
50. Magazine Release Pin-Dowel Pin 1/8 by 5/8
51. Magazine Release Spring-MW

PARTS LIST (CONT.)

52. Tank Mount Shader
53. Tank Mount - CR
54. Tank Mount O ring - $3/4 \times 9/16 \times 3/32$
55. Tank Mount To Firing Valve Fittings
56. Airline - $1/4 \times 3/16$ Tube
57. Tank
58. Tank Valve - CR
59. Tank Valve O ring
60. Tank Valve Body - CR
61. Rear Grip Body - CR
62. Rear Grips - Plastic
63. Front Grip Body - CR
64. Front Grip Body Ring - Tube
65. Front Grip Body Strap - CR
66. Front Grips - Plastic
67. Grip Screws Male & Female
68. Magazine - CR
69. Magazine Rear Plate - CR
70. Magazine Bullet Holders Left & Right - 01
71. Magazine Follower - Plastic
72. Magazine Follower Spring - MW

CALIBER CHANGE FORMULA to shoot similar ballistic bullets. Select telescopic D.O.M. tubes for receiver, bolt and striker assembly for these approx. weights. Bolt weight ~~to~~ to ~~X~~ X bullet weight $\leftarrow 40X$ (varies with barrel length.) Striker assembly 85% of bolt weight. Cross section area through firing valve and its orifice should equal $\frac{1}{2}$ cross section of bore. Try to keep lengths approx. the same, however lay the action out to allow for a change in the distance the bolt moves before the O ring reaches the loading port, it should be approx. $2.4 \times$ bore dia. Also increase & decrease striker spring tension with bore cross section.

RAW MATERIAL KITS - consists of the metals & tubes to be machined with one stamped magazine, less barrel, tank, springs, ect. ~~\$75.00~~

COMPLETE MACHINED KITS - unassembled fireable gun, less grip sculpturing, exterior finish, and tank. - P.O.R.

MAGAZINES - Stamped blanks \$7.50 - Complete magazine ~~\$50.00~~ P.O.R.

BULLET MOLDS - 2 cavity Lyman 85 gr. .311 \$45.00 - 2 cavity Lee 100 gr. .311 \$30.00

LIGHT WEIGHT TANKS - We are seeking a cost efficient supplier. P.O.R.

CONSTRUCTION & PERFORMANCE VIDEO - \$40.00

NEWSLETTER OF THINGS TO COME - Purchasers of plans will receive the latest information on our work and new products.

Prices subject to change without notice. Add \$5.00 shipping charge.

HOW THE GUN WORKS

This gun is a basic blow back system designed to operate from the peak pressure of a pre-pumped detachable tank of approx. 100 cubic in. capacity which is the shoulder stock.

The gun has a 30 round detachable magazine that when it snaps into the magazine housing releases all its bullets to flow freely into the loading port. The bullet mold was selected to cast a 1 in 40 parts tin bullet, that would strip off each other without hanging up.

Pressure drops slightly from shot to shot, but the valve tends to compensate for it some, as the valve is harder to strike open at higher pressure and lets more air out at lower pressure. A good polish of receiver tube ID., bolt & striker are very important because it takes over a 150 lb. blow to open the firing valve, which has to recock on momentum of the bolt.

Manual cocking is done by forcing the cocking pin on the striker into the bolt so it will come back with the striker. Upon letting go, the sear holds the striker, the cocking pin spring releases the bolt, letting it pick a bullet out of the loading port shoving it into the firing chamber past the air inlet from the firing valve. The bolt being in the proper place for firing allows the disconnecter to come forward by going into the small off-set slot in the bottom of the bolt body. This lets the disconnecter pull down the sear upon pulling the trigger letting the striker hit the firing valve. In the first stage of the trigger the striker follower will recoil with the bolt and hit the disconnecter releasing the sear, which establishes semi-auto fire, as you pull on down to the next stage the auto sear trip comes up to trip the sear for the next shot when the bolt comes home.

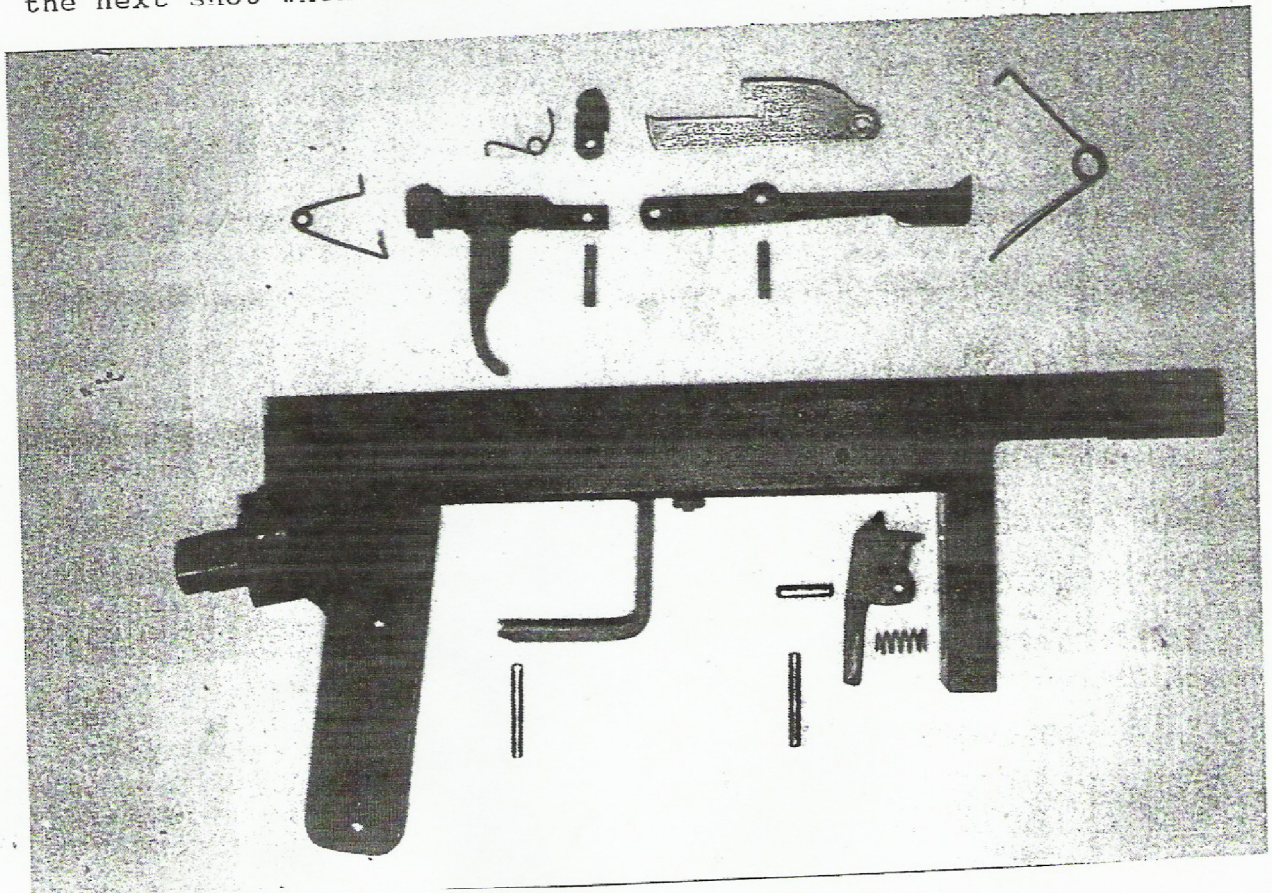

CONSTRUCTION TIPS

Drilling the firing valve outlet is done after welding it to the receiver. First place barrel in receiver in proper place. Drill and tap 1/4-28 hole 1/2 inch from front of receiver on the bottom, install allen screw to hold in place. Next mill out loading port and drill vent holes. Roll receiver 90 degrees and put 3/4 round bottom groove 1/16 deep for firing valve body, you also cut 3/4 round through barrel shoulder at same time. Now position and drill 7/32 hole for air inlet in receiver and halfway through barrel at same time. Pull out barrel and in same setting drill on through receiver. Next line up firing valve body and weld in place 3/4 inch welds top and bottom. Be careful not to weld to close to threads. Now firing valve can be drilled through receivers 7/32 holes. Next screw firing valve holding area on tight and locate hole for 1/8 NPT in the end of holding area so that it is down. This hole plums to the tank mount with 90 degree 1/8 NPT to 1/4 brake line fitting.

Making bolt start with 3/4 stock and locate where large dia. is, cut this area down .020 on lathe then build back up with brass over size (approx. ten-thousandths.) Turn down and polish .002 under receiver tube ID. Then finish bolt dimension. Cut O ring groove with 1/16 wide cutter with a nose radius of 1/32 go .060 deep.

Trigger housing is made out of rectangular tube with top milled off and cut to dimension. The front mount (part 30) is welded in place, flush with the front, with radius up. The rear mount screws under receiver at 9 3/16 & 9 11/16 with two shouldered 10-32 screws with front mount in place, put in front screw, this will locate 10-32 hole inside of rear mount through # 10 hole in trigger housing.

Study trigger and sear assembly before cutting out. Hand fit to your gun the relationship between the hook on the disconnecter with the sear, also the auto-sear trip with the bolt. If the disconnecter swings down to far before it hits the sear, just as the sear is going to catch the striker assembly, the downward movement of the disconnecter will knock the sear down, not catching the striker thus allowing the striker to be slowed down by the bolts function going home. The result, a weak strike on the firing valve. A small wedge of O1 tool steel may be added to sear above where the auto-sear trip sets to make the sear catch point 1/4 inch wide by brazing before hardening. The trigger assembly parts must be polished and allowed to move freely in trigger housing. E-clips may be used as spacers on trigger. The sear and full auto sear trip share center line in the trigger housing. The full auto sear trip sets on the left in the 1/8 inch slot, in the magazine housing.

CONSTRUCTION TIPS (CONT.)

The sear is held in place by a $3/16$ dowel pressed in the trigger housing with a $1/4$ inch long spacer holding it on its half of center line. A torsion spring wraps around the spacer made of .041 music wire with a $1\ 3/8$ inch leg on the outside with a 90 degree bend $3/8$ long. On the floor of the trigger housing. On it's third revolution coming up, at approx. 90 degrees it extends $1\ 5/16$ with a U shaped cup 90 degrees away from the coil to hook under the sear.



The disconnecter pivots on a dowel pressed in the trigger frame block, after the full-auto sear has slid on center line with the sear. It's spring torsion that wraps around $1/8$ dowel that the disconnecter pivots on. It's made of .026 music wire with a $9/16$ leg on the outside with a 90 degree bend $1/8$ long leg. It goes in the tiny hole in the trigger frame block. After its third revolution coming up at approx. 90 degrees it extends $7/16$ from center of coils with a U shaped hook away from the coils to go into the disconnecter.



The trigger pivots on a $1/8$ by 1 dowel pin pressed into the trigger housing. Trigger spring torsion wraps around its pivot pin on the left side. It is made of .041 music wire with a 1 inch leg on the outside with a 90 degree bend $3/8$ long leg on the floor of the trigger housing. After its 1st revolution it comes around 300 degrees and extends .700 with a U shaped cup, 90 degrees away from coil to hook under thin portion of trigger frame block.

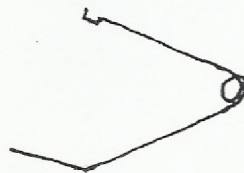

Video show these springs being made

CONSTRUCTION TIPS (CONT.)

The following springs were wound around their pin sizes in a vise, as tight as possible. They were formed with pliers and baked in the oven at 550 degrees to 625 for 35 to 45 minutes.

Compression springs were stretched around a mandrel. The lead screw was set for the pitch, made with closed and ground ends, then baked in oven.

The magazine spring was stretched around an oval bar 1/4 in. by 1/2 in. about 14 in. long at 1/4 pitch wound off by hand, then reset by hand with small pliers and baked. Note; Spring will crawl forward in oven.

The magazine was made by milling out a punch and dye with a 3/8 round end mill and a 5/32 radius corner rounding mill. After formed, spot braze together, and a 5/16 button forced through it with shims to insure proper inside dia. a.400 by 1/8 notches were cut in the sides of the opening for the lugs on the bullet holders to recess in, then braze on bullet holders 1 in. back from end. Allow a little clearance then heat to deep red (not bright,) Dip in oil then draw back to spring hard. Make catch assembly as shown in magazine follower, put spring in, then follower. This magazine will hold lead alloy bullets while loading and handling. When magazine locks in magazine housing the receiver spreads the bullet holders, letting the bullets flow freely into loading port. The magazine catch is cut into magazine by putting layout blue or black magic marker on magazine sliding it in magazine housing. The magazine release will scratch the blue and show where to cut retaining groove.

Tank selection is important. Be careful in finding or building a tank that it will handle the pressure. You may pressure test a tank with a port-a-power pump to 1000 over pressure required. This would be the safest way. Note part 53 that welds to trigger housing is milled off at an angle, so the tank will clear the receiver approx. a 10 degree angle. Our tank was 3 5/16 in. dia. by 13 3/8 long with 1/2 NPT fitting. If using a different size tank check layout for clearance and adjust angle for fit.

Tuning the weapon is done by adjusting the spring tension on the striker, at the breech block in the rear of the receiver, while maintaining just enough spring tension to force the bolt home. (Shimming the inside bolt spring may be necessary.) Lower pressures may require winding a softer striker spring.

The firing valve stem protrusion distance is critical, if it is too short it will not let out enough air. If it is too long it will cause excessive chamber pressure, which will shock load the magazine spring and collapse it. I suggest .125.

PRESSURE & PERFORMANCE

There are many sources of air. Dive shops, divers tanks, small DC compressors from military surplus, aircraft strut pumps and shop built hand and motor driven, two & three stage pumps.

A good starting pressure is 3000 lbs., although I am sure the gun will operate as low as 1000 lbs. with some tuning. Keep in mind that liquid CO₂ is 1000 lbs. at 83 degrees, and as long as there is a liquid portion in the tank the pressure would remain the same at that temperature. This would give several hundred shots per tank and it could be filled from a fire extinguisher.

Our velocity formula is $V = \sqrt{2AD}$. Take the cross section of the .311 bore (.0759) by the air pressure (3000) = 2277 X the # of 100 gr. bullets per lb. (70) = 15939 gives acceleration in g's $X 32.2 = 513235.8 X$ twice the barrel length in feet (4) $\sqrt{2052943.2}$ equals 1432.8 ideal velocity.

Our goal is to operate 70% efficient which would give 1000 fps.

TROUBLE SHOOTING

1. Weapon Won't Recock
 - A. To much spring tension
 - B. Weak strike on valve
 - C. Striker or bolt assembly binding
2. Quits Firing After Weak Second Shot
 - A. Sear not catching striker
 - B. Spring tension wrong
3. Jamming
 - A. Check allignment of magazine to loading port
 - B. Spring to weak in magazine
 - C. Bad bullet design
 - D. Bullet to soft
 - E. Need radius from loading port to bore axis & polished
4. Semi-Auto Function Fails
 - A. Sear binding or lack of upward tension
 - B. Trigger spring to weak
 - C. Disconnecter to sear relationship off
5. Excessive Loading Port Pressure
 - A. Sear binding or lack of upward tension
 - B. Bullets to hard
 - C. Valve stem to long
6. Low Power
 - A. Weak strike on valve
 - B. Valve stem to short
 - C. Binding in striker assembly
 - D. Barrel needs lapped
 - E. Bolt O ring blown

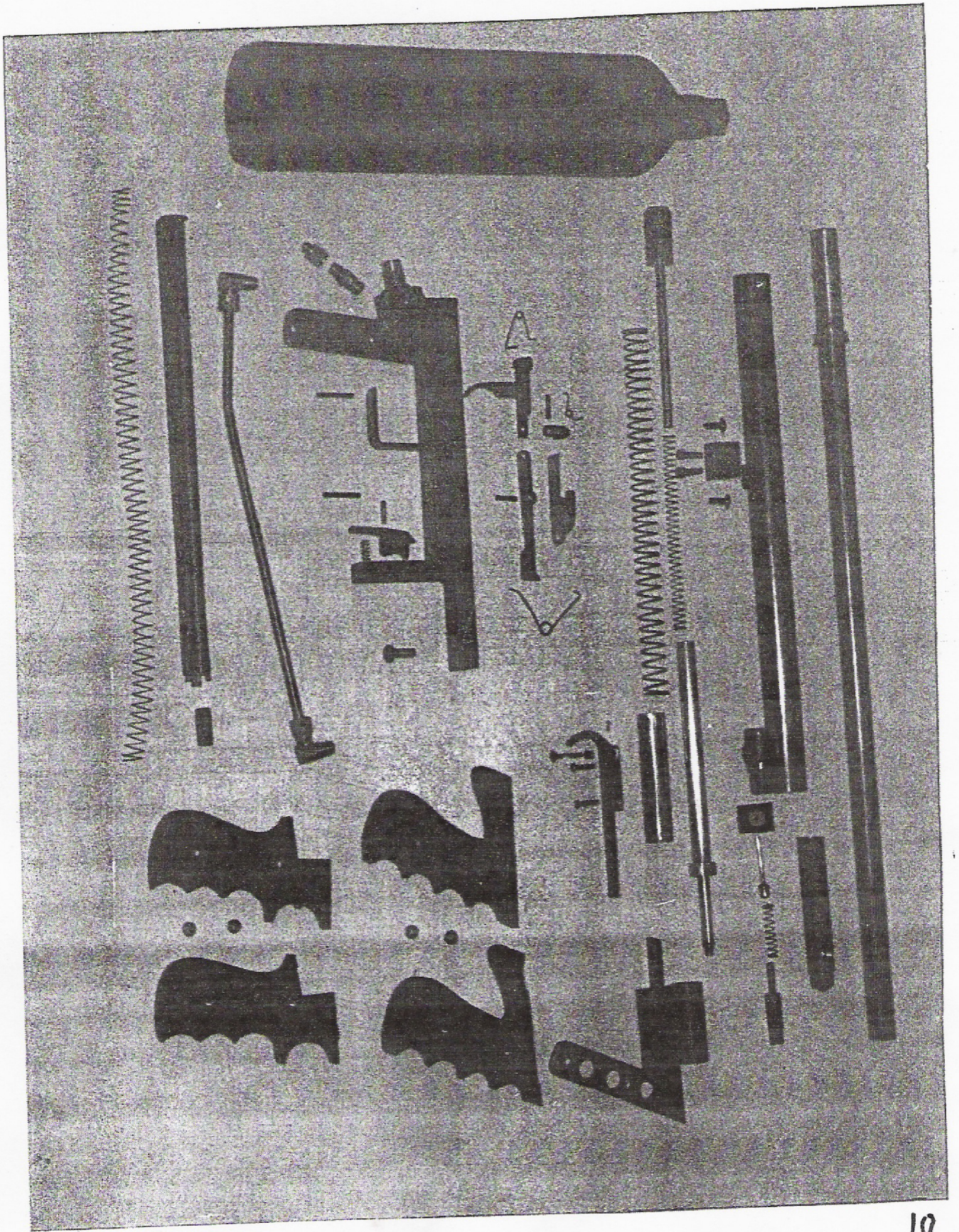

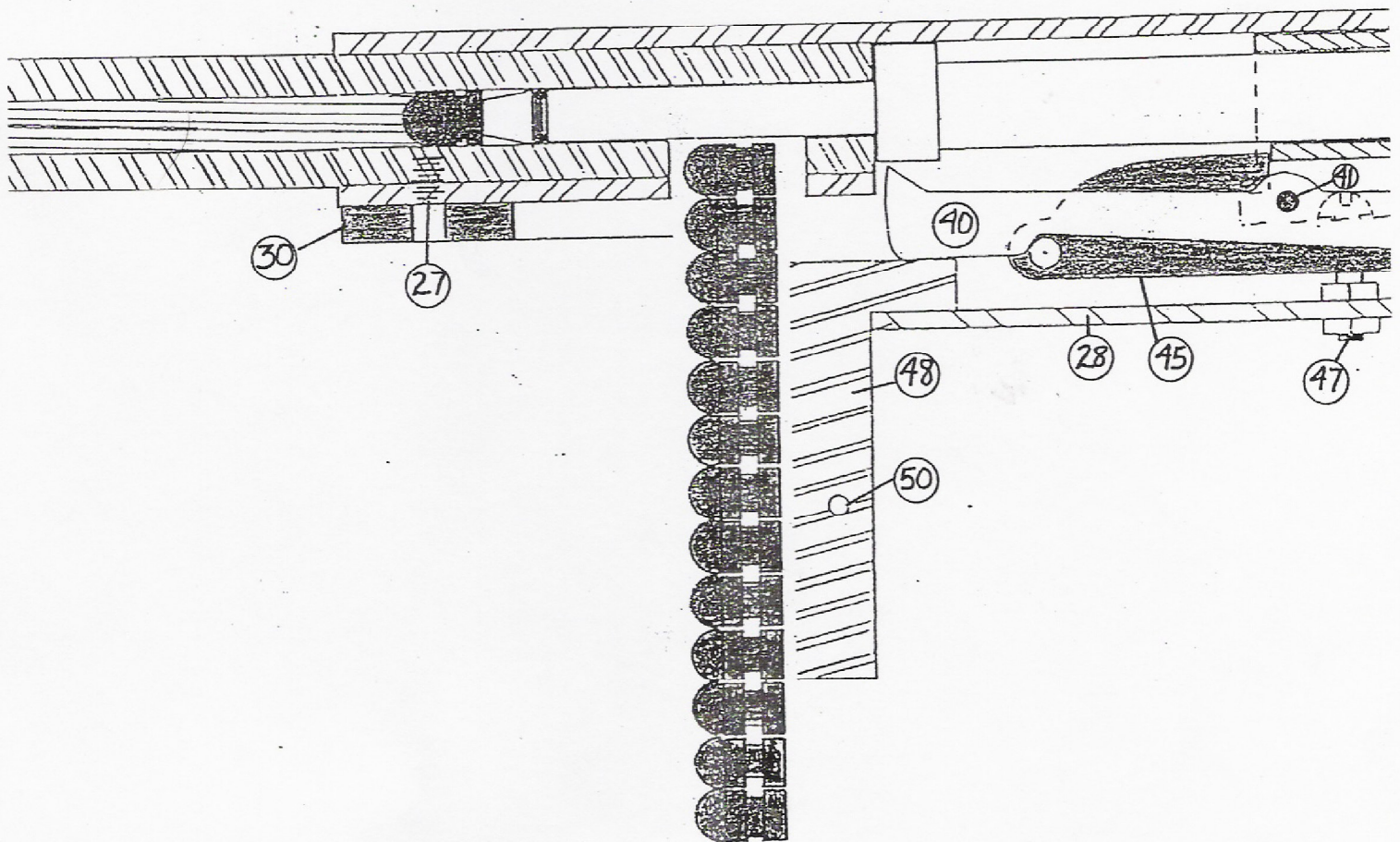
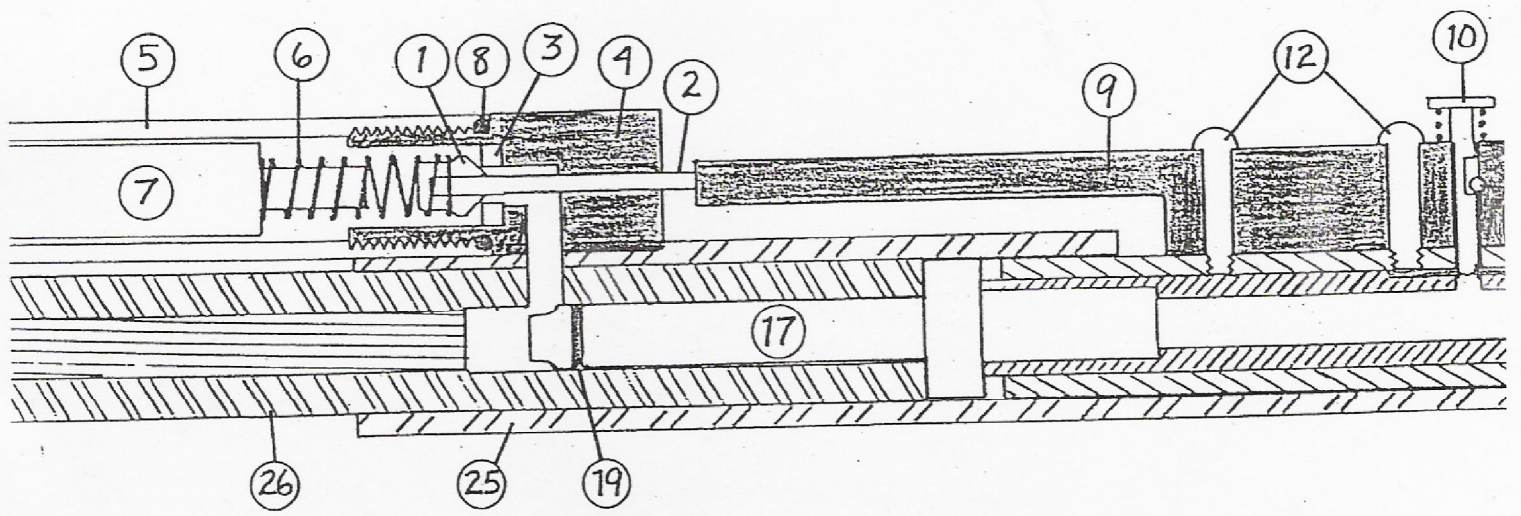

Cocking Pin must slide freely in bolt body slot
Press in to pull bolt back

Bottom view

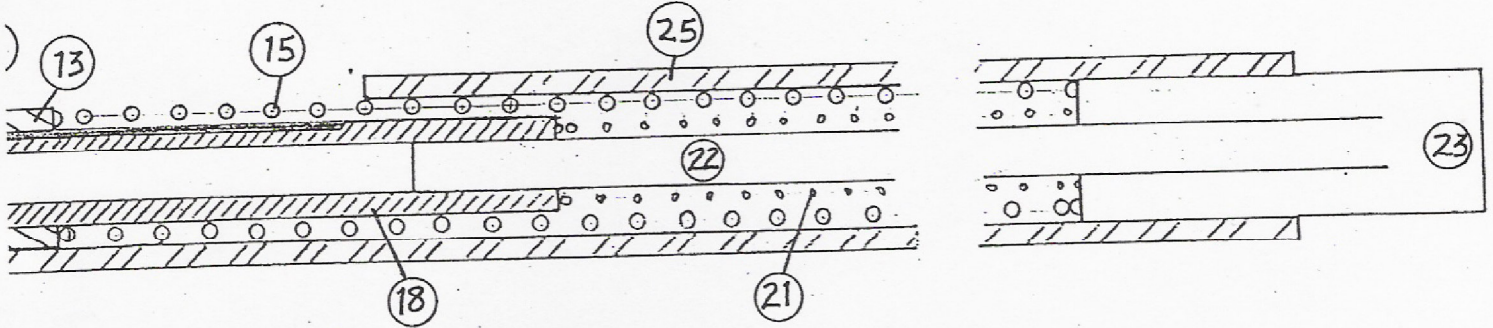

Left side view

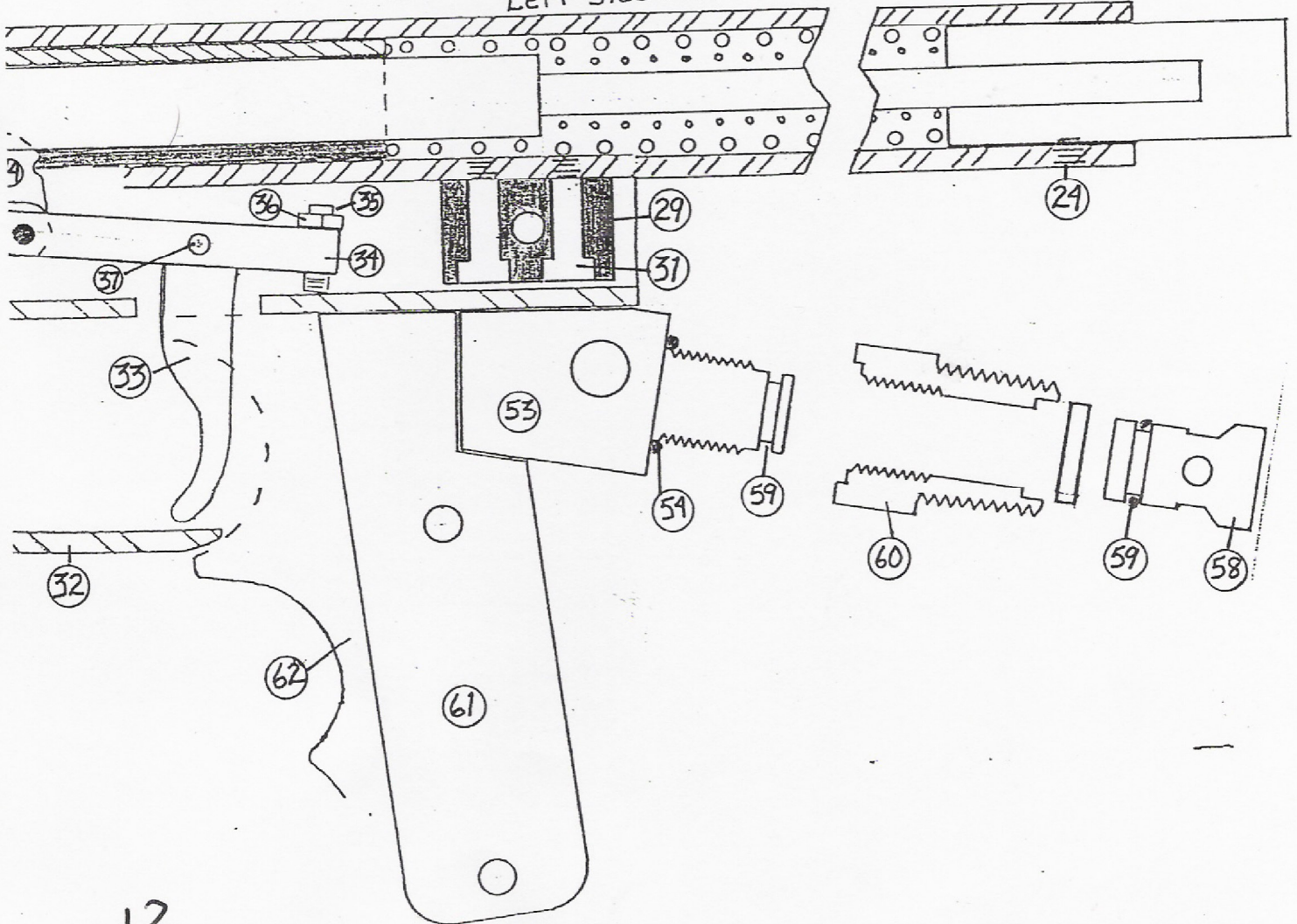

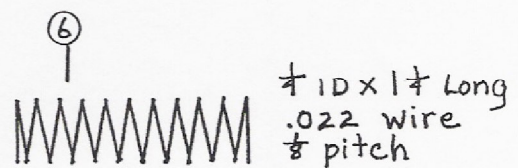
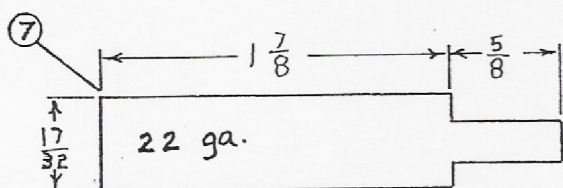
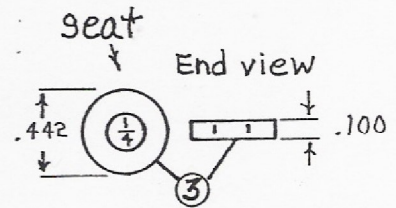
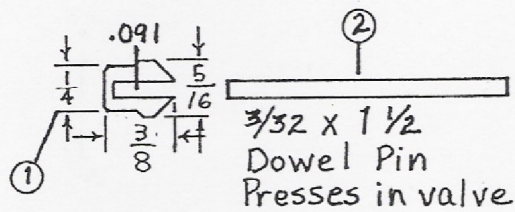
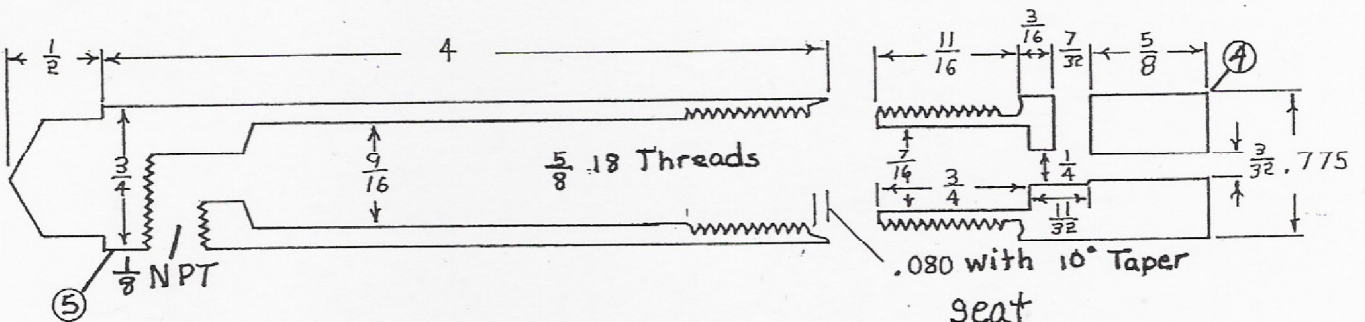
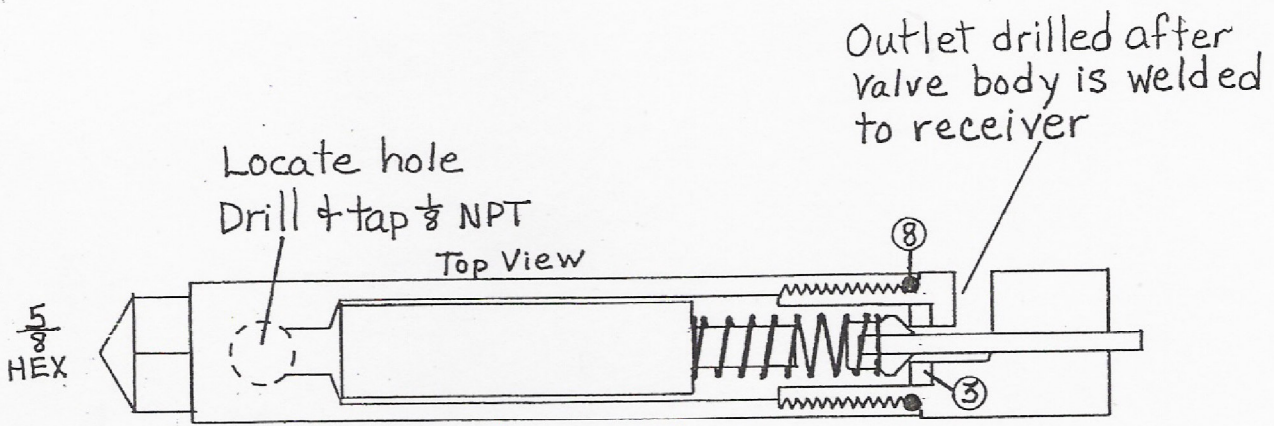

1. Firing Valve
2. Firing Valve Stem
3. Firing Valve seat
4. Firing Valve body
5. Firing Valve holding area
6. Firing Valve spring
7. Firing Valve spring guide
8. Firing valve O ring

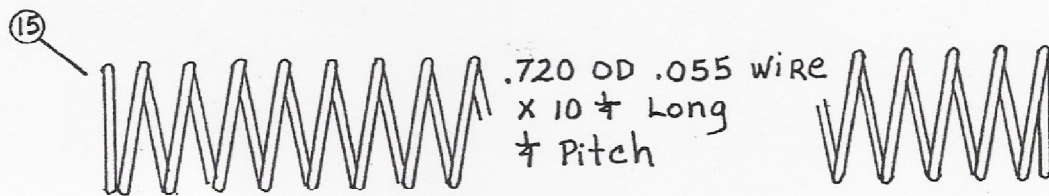
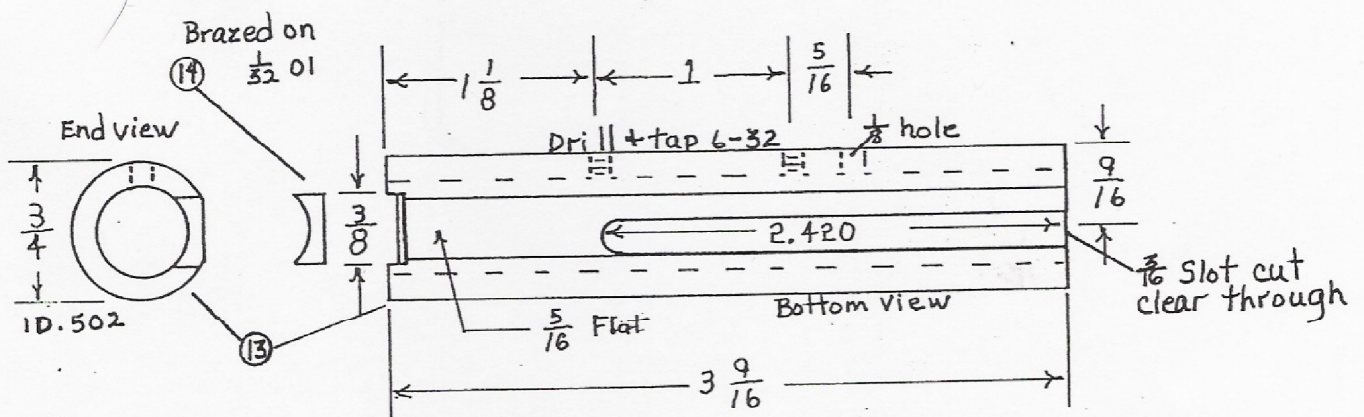
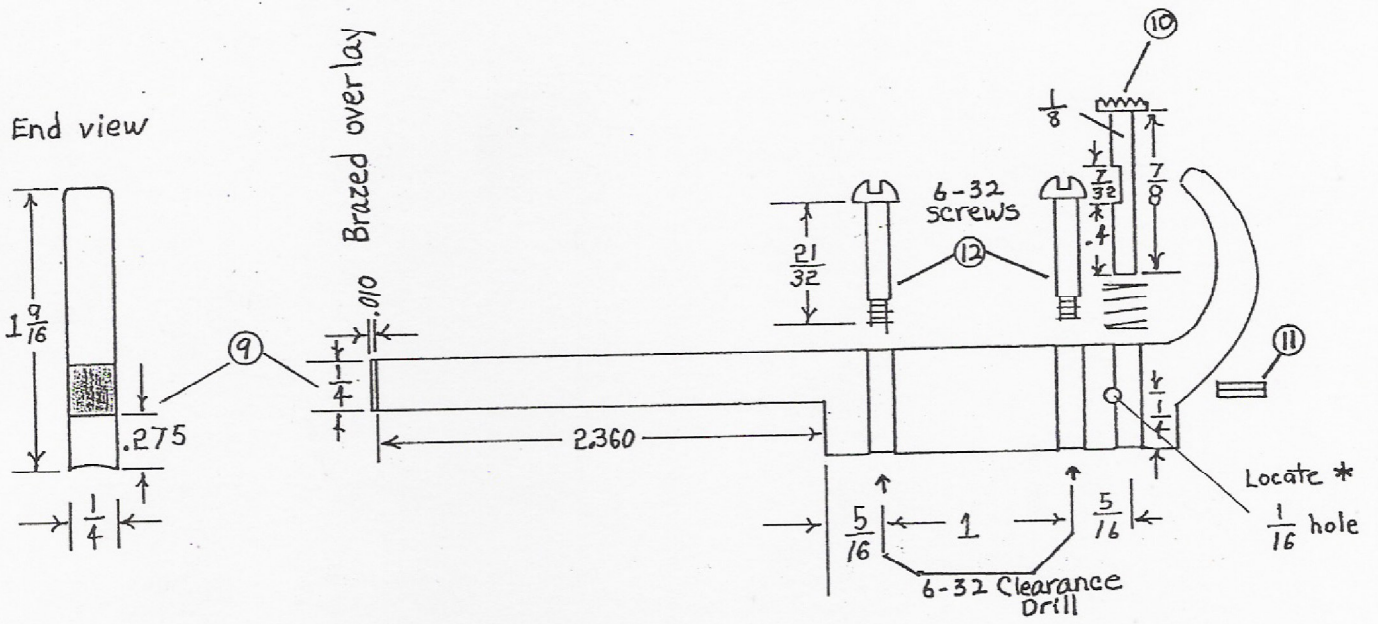

* Locate so cocking pin will protrude only .155 until pressed

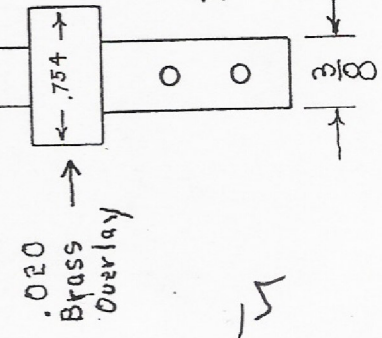
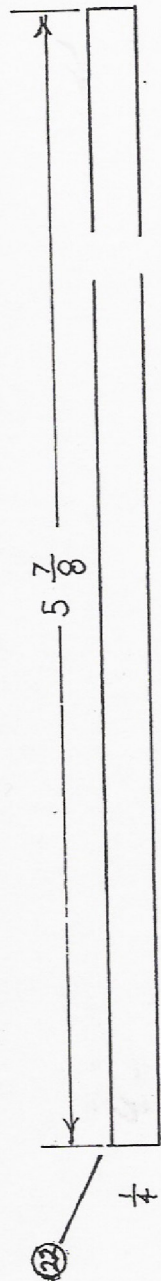
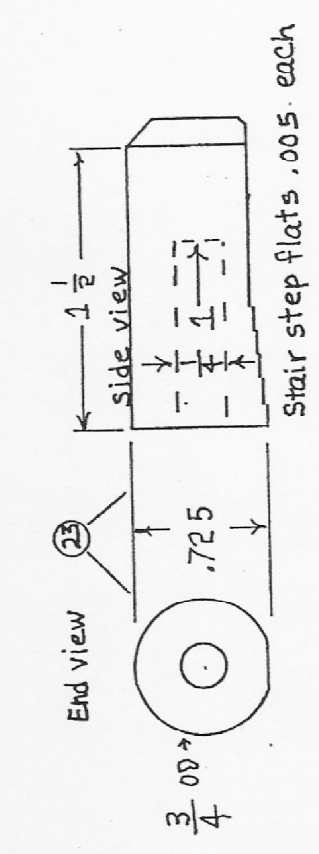
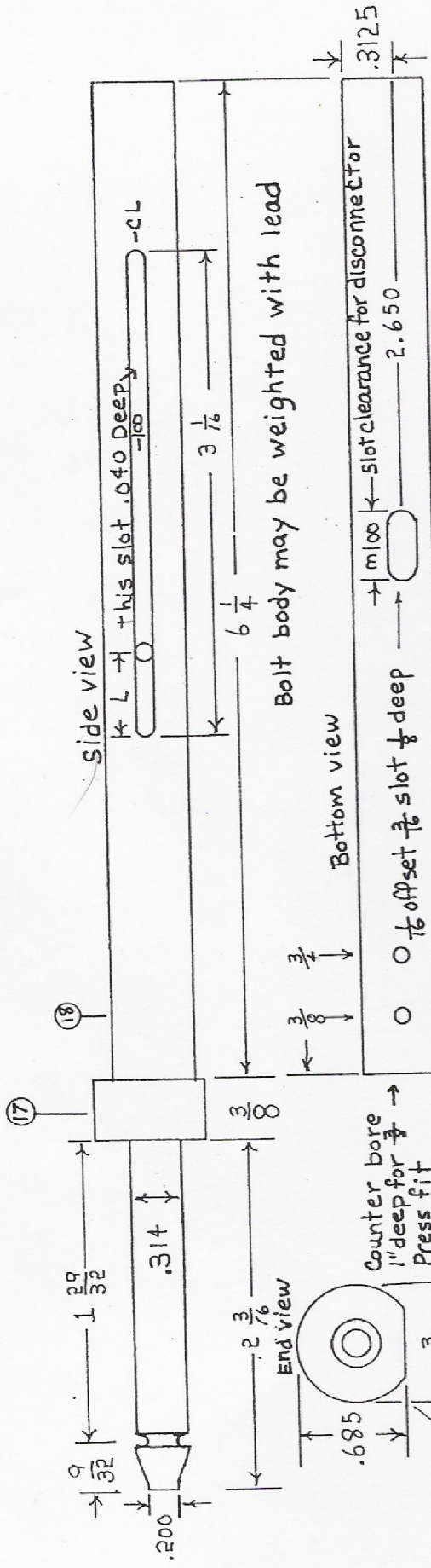

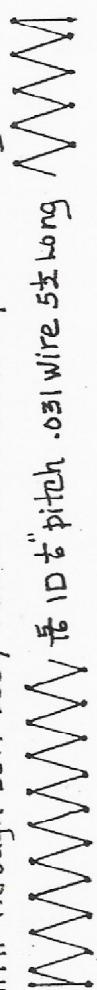
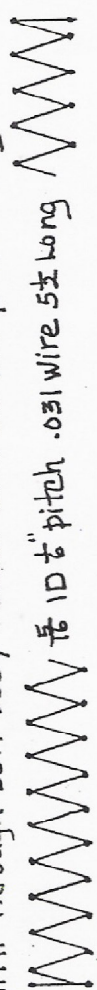
$\frac{3}{32}$ holes locate drill through bolt body retain with $\frac{3}{32}$ roll pins ± Long

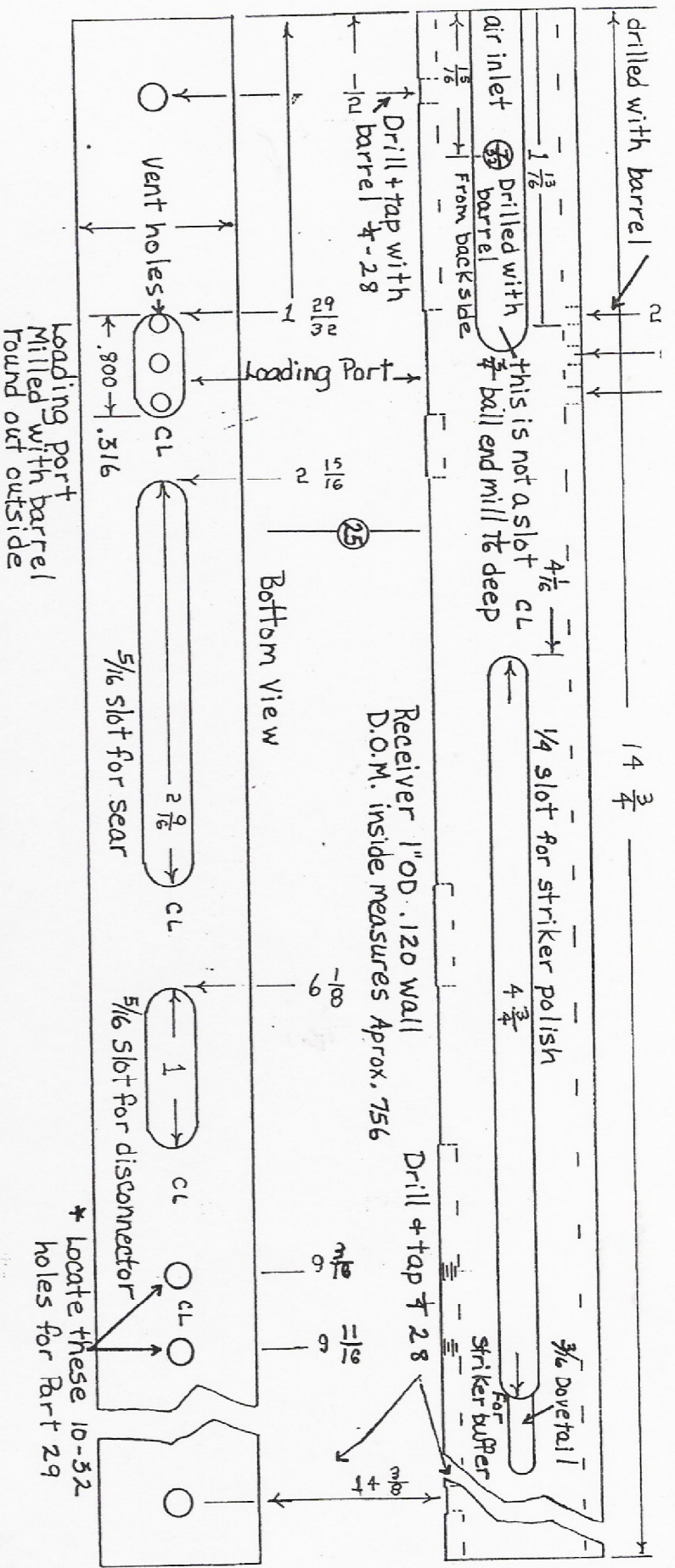
 $\frac{1}{16}$ ID $\frac{1}{4}$ pitch .031 wire 5± Long 

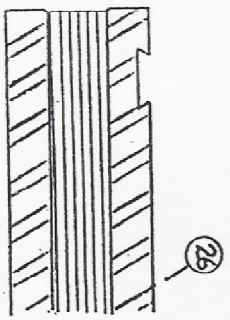

Barrel .311 bottom groove

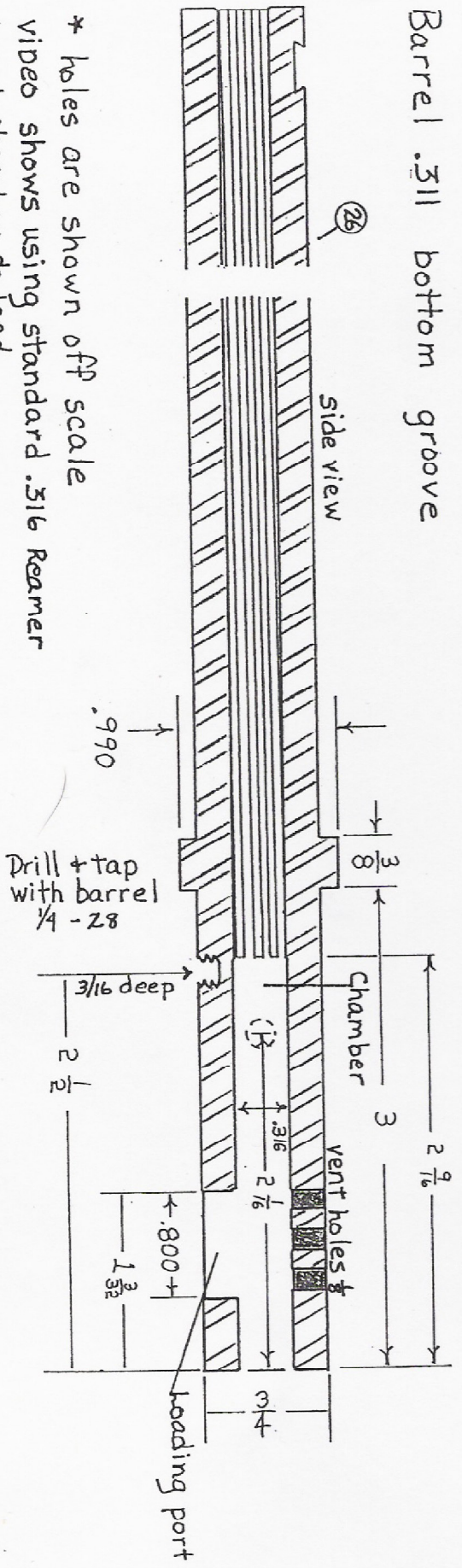

side view



* holes are shown off scale
 video shows using standard .316 Reamer
 to cut chamber + lead

Bottom view

Rear slot cut to weld tank mount through

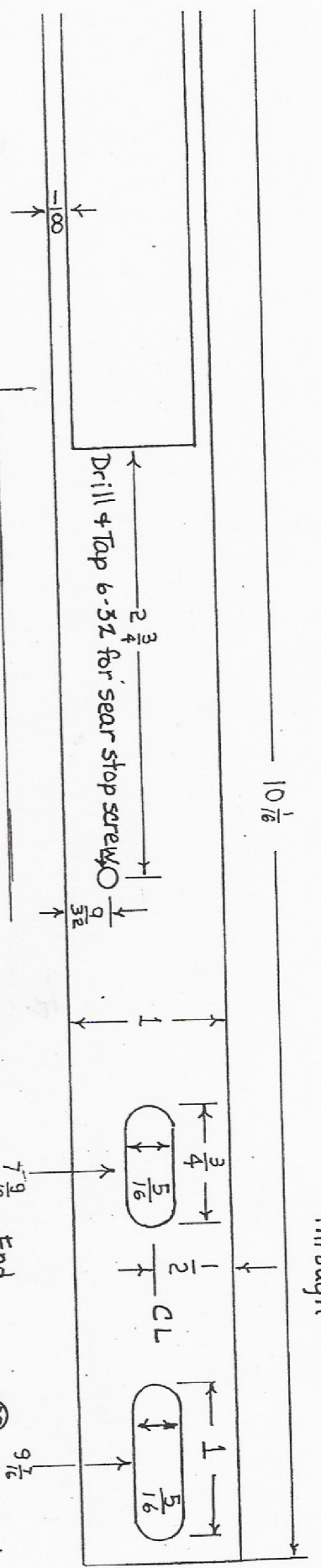

Made out of 1x1/8 square tube
top cut off + beveled

Part 29 screws to receiver with 2 10-32 screws to trigger housing 2 10-32

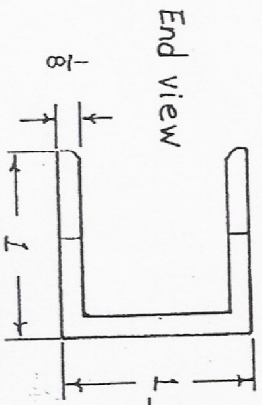
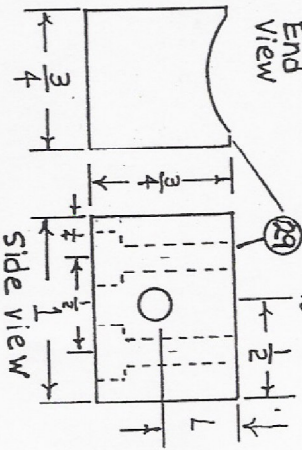

Side view

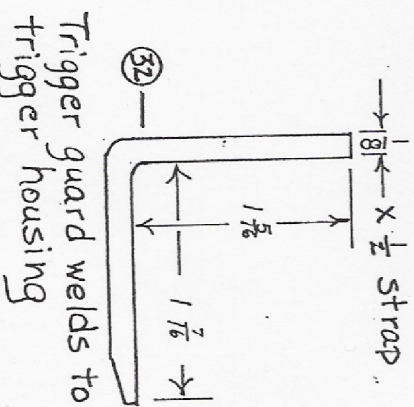
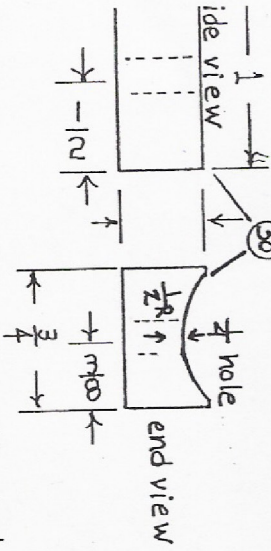
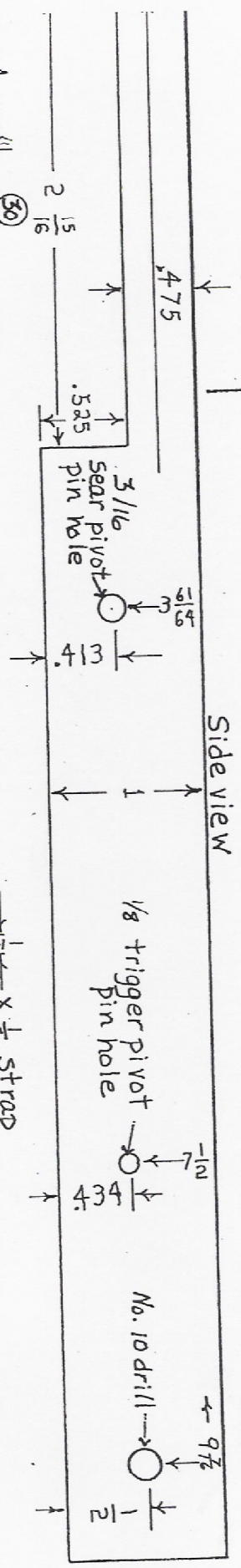

rt 30 screws to receiver + barrel with a 1/4-28 and welds to trigger housing

48

End view

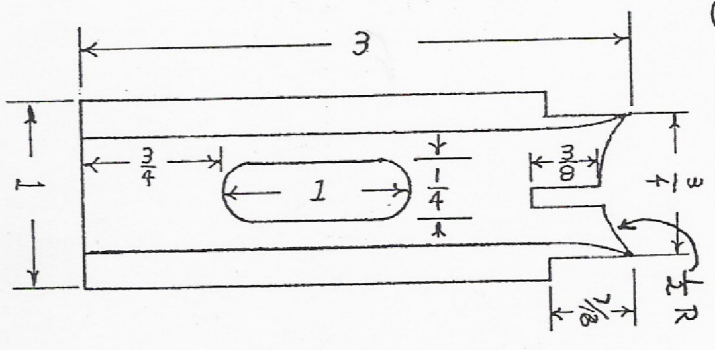

Side view

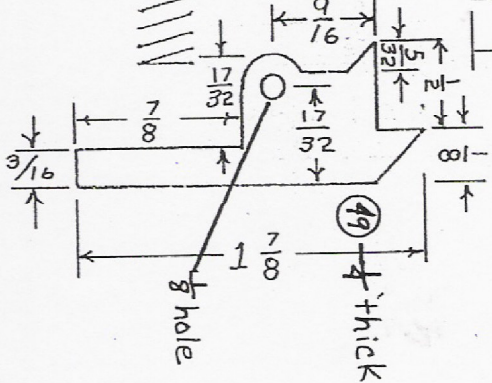
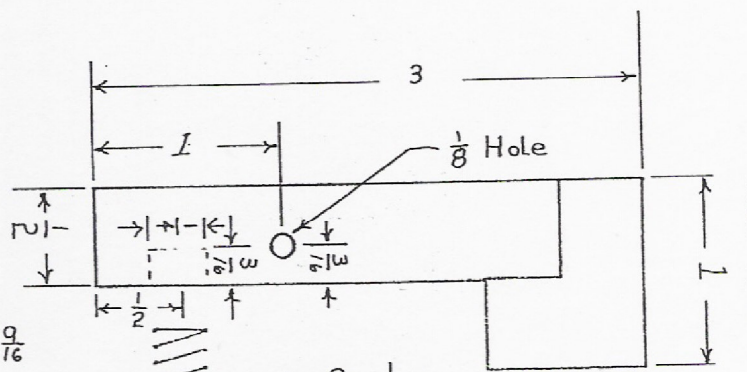

Rear view

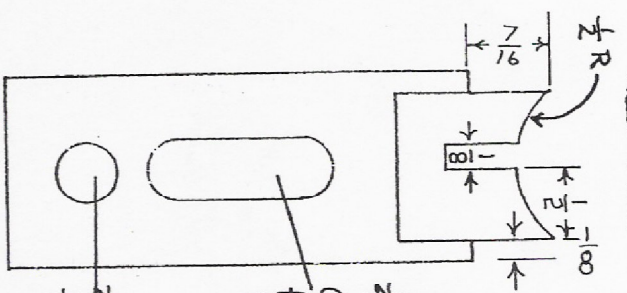

Slot cut
clear through
for magazine
Release

hole $\frac{1}{8}$ deep
to hold spring

8/

60° 3/4 Dovetail

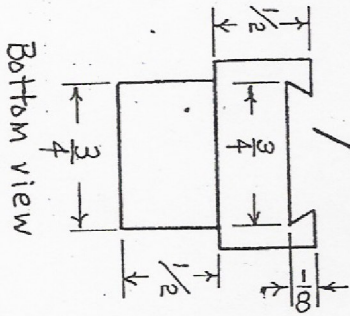

Bottom view

Recessed part of magazine housing
slips in trigger housing + welds

- 33. Trigger
- 34. Trigger frame block
- 40. Full auto sear trip $\frac{1}{8}$ " of tool steel - harden
- 41. Disconnecter $\frac{1}{8}$ " of tool steel - harden
- 45. Sear $\frac{1}{8}$ " of tool steel - harden

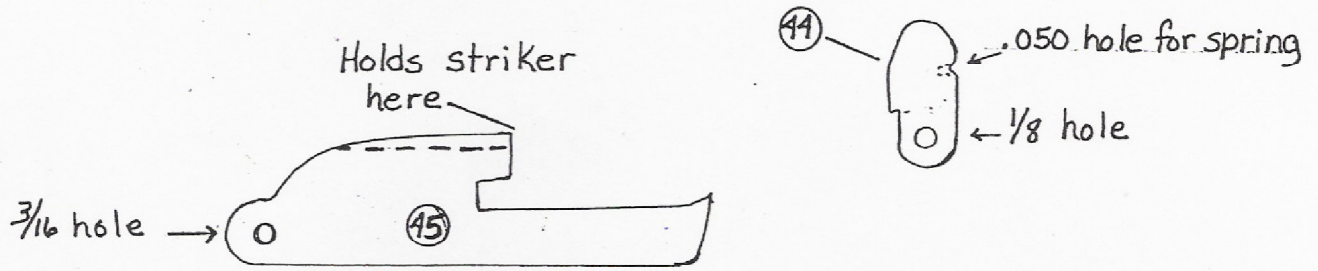

Additional of wedge may be added to double sear width

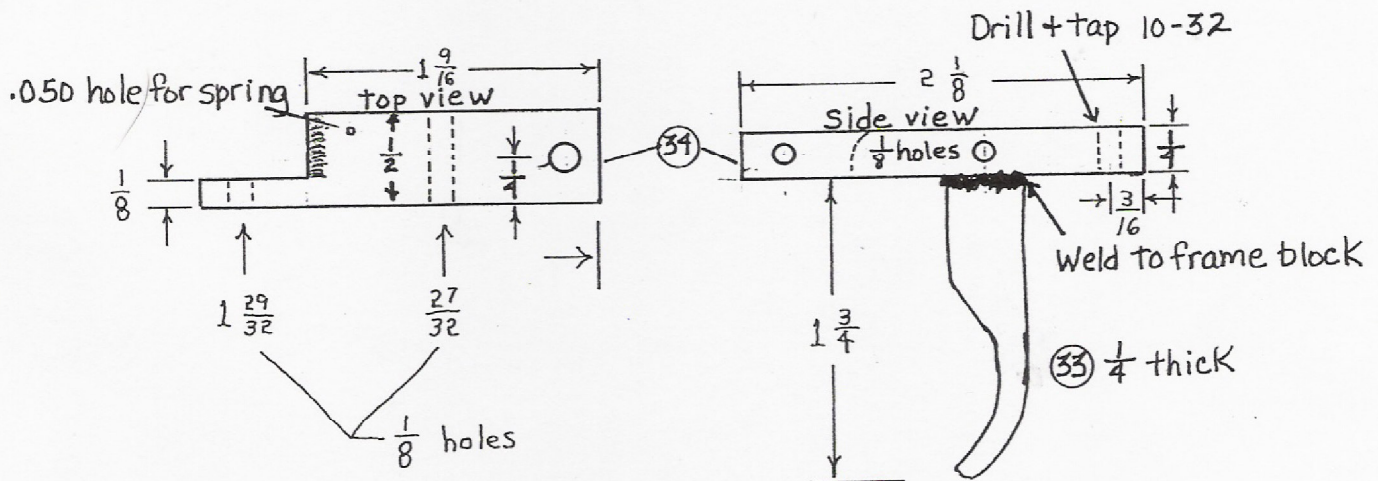
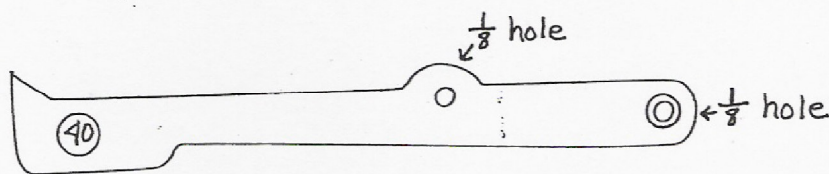

Use this page for pattern
 Copy & double face tape
 to material to saw out or
 make tinplates ect...

$\frac{7}{8}$ OD tube $\frac{3}{4}$ ID slides over barrel

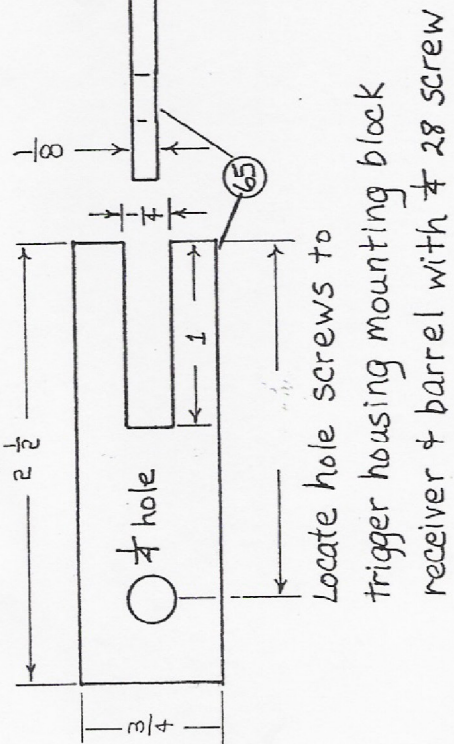
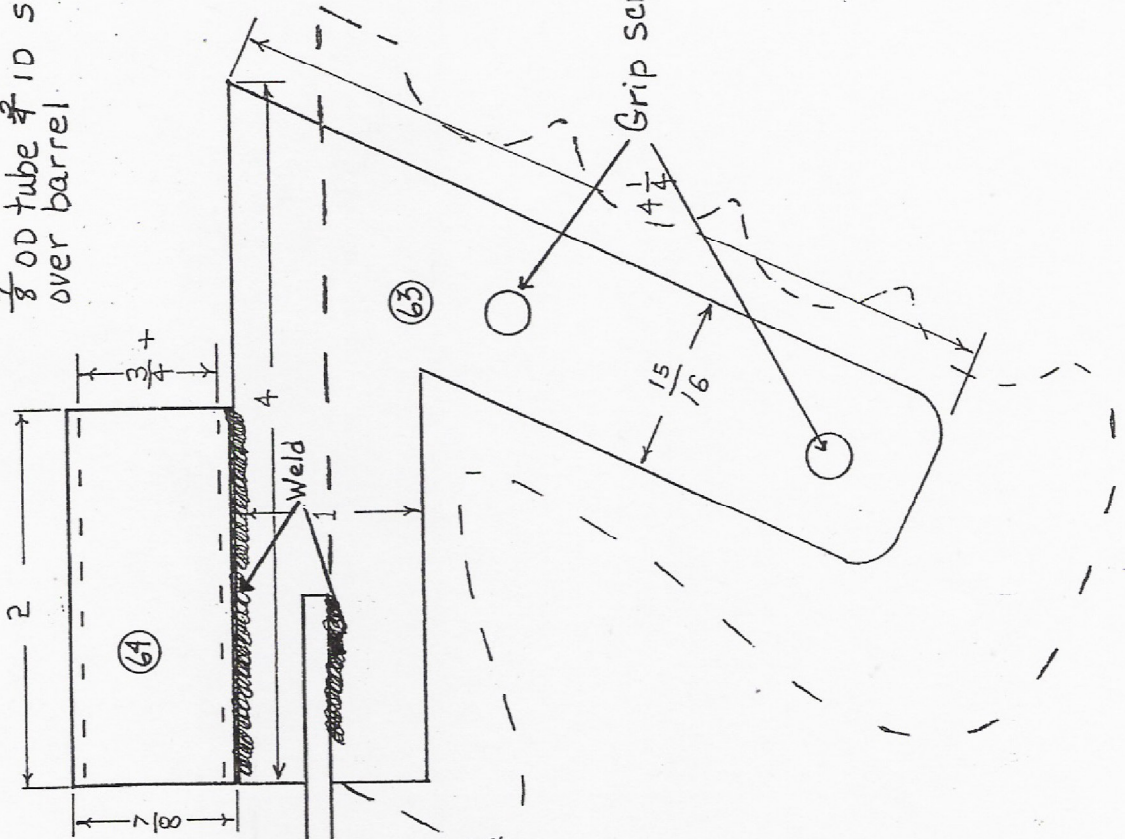

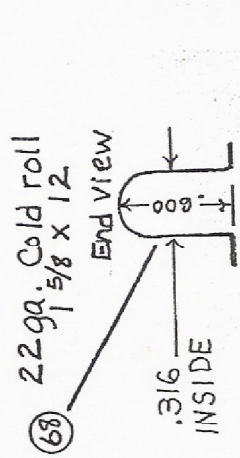

Braze together

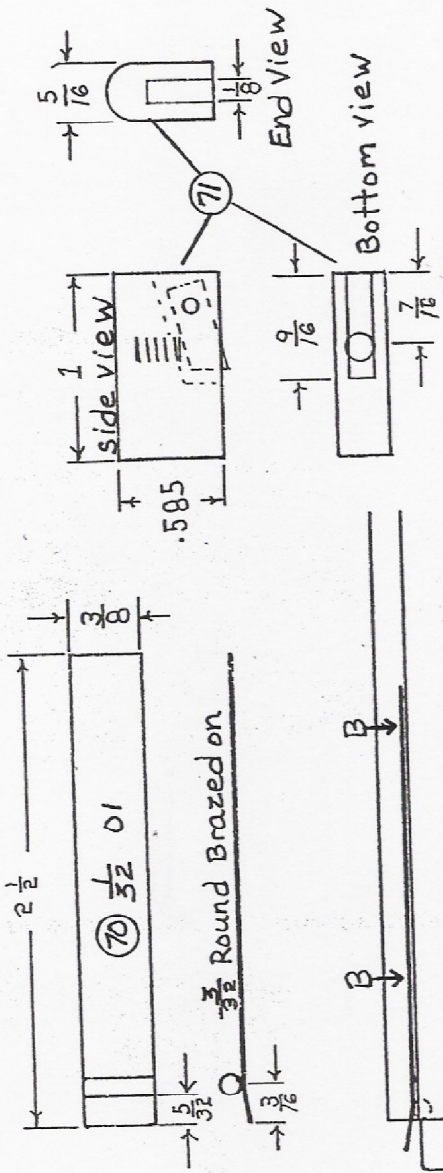
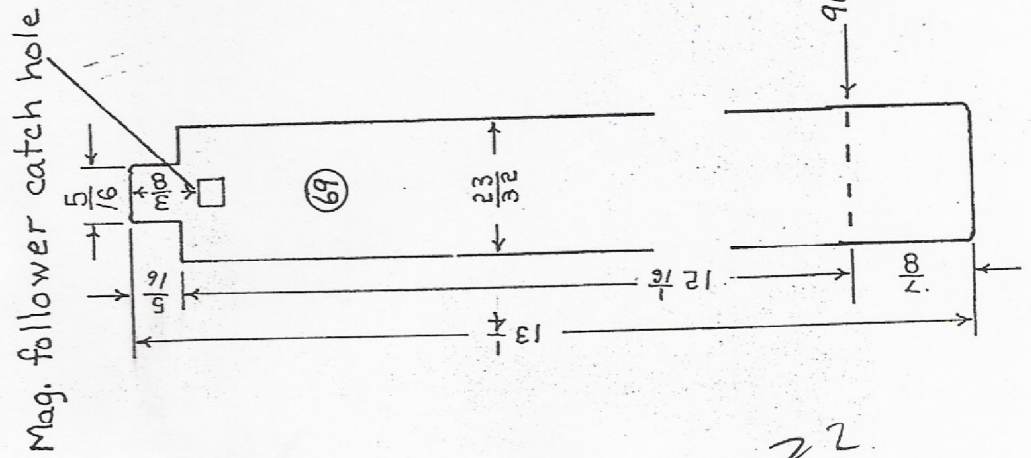

Mag. follower catch prevents follower from coming out and staying in gun

B Braze bullet holders on magazine 1" back from end. Heat to deep red - dip in oil then draw back to spring hard

Magazine spring .029 music wire discussed earlier ~ construction shown in video

SIMPLE TRIGGER ASSEMBLY

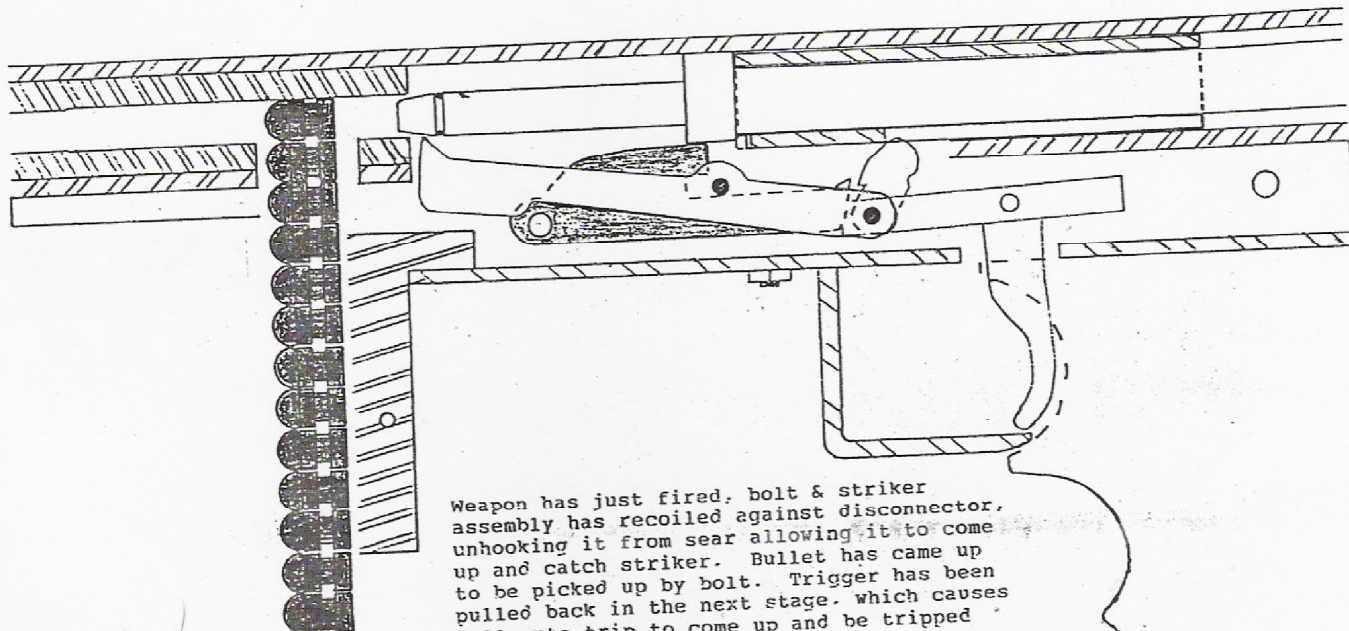

Weapon has just fired, bolt & striker assembly has recoiled against disconnector, unhooking it from sear allowing it to come up and catch striker. Bullet has come up to be picked up by bolt. Trigger has been pulled back in the next stage, which causes full auto trip to come up and be tripped when bolt goes home.

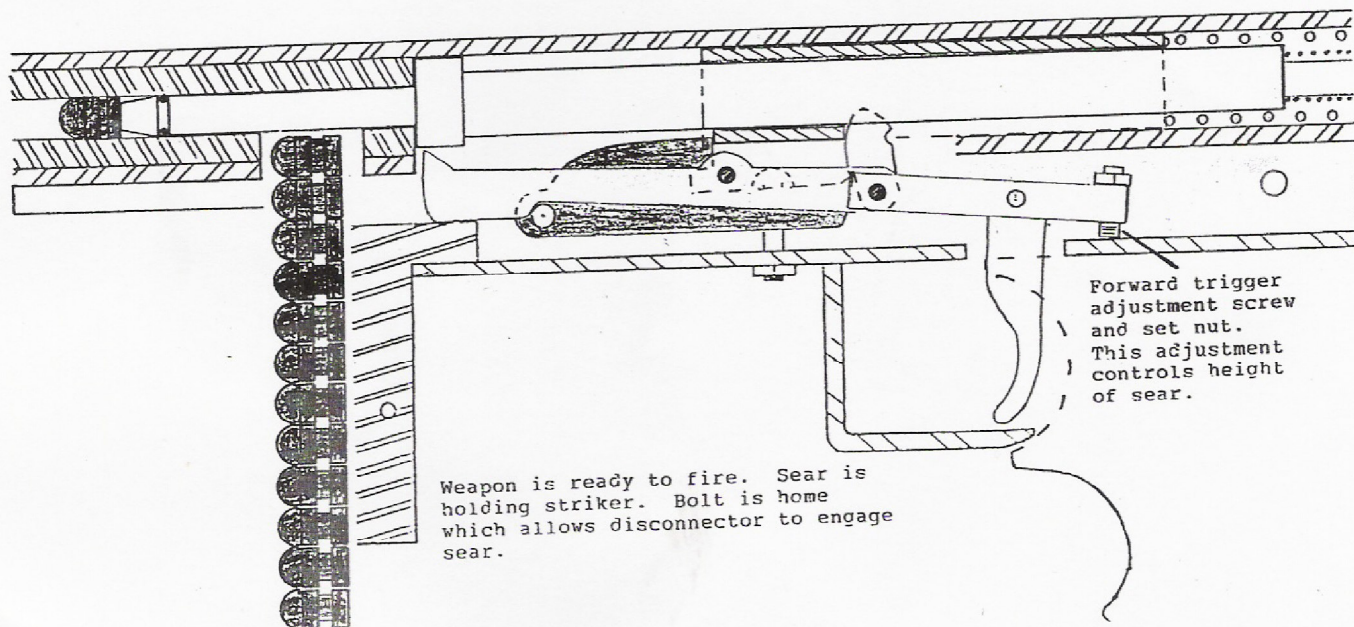

Weapon is ready to fire. Sear is holding striker. Bolt is home which allows disconnector to engage sear.

Forward trigger adjustment screw and set nut. This adjustment controls height of sear.

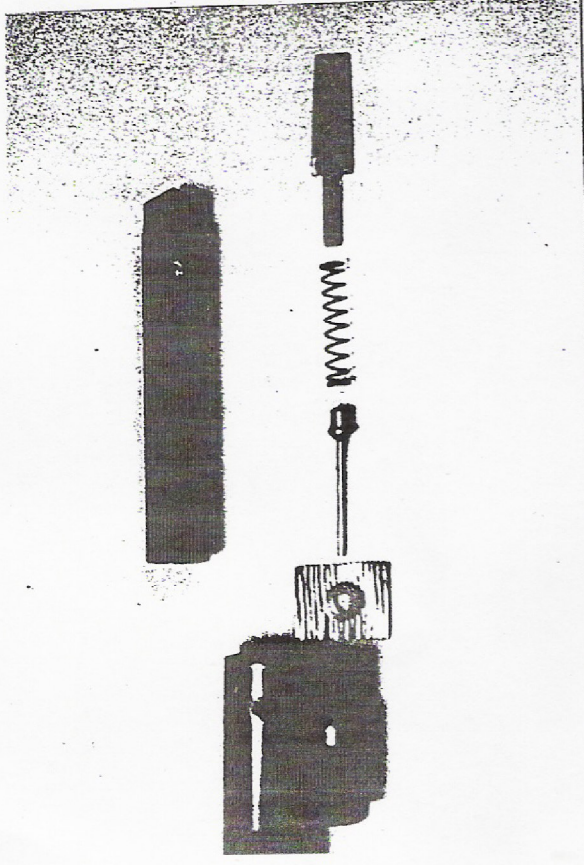

ring valve

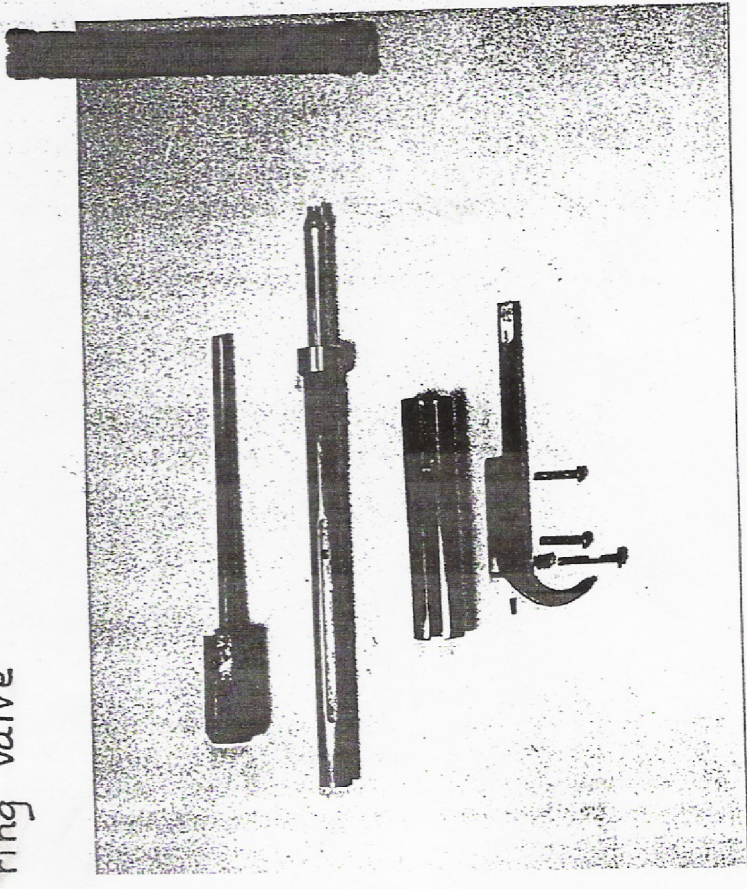

bolt + Striker assembly

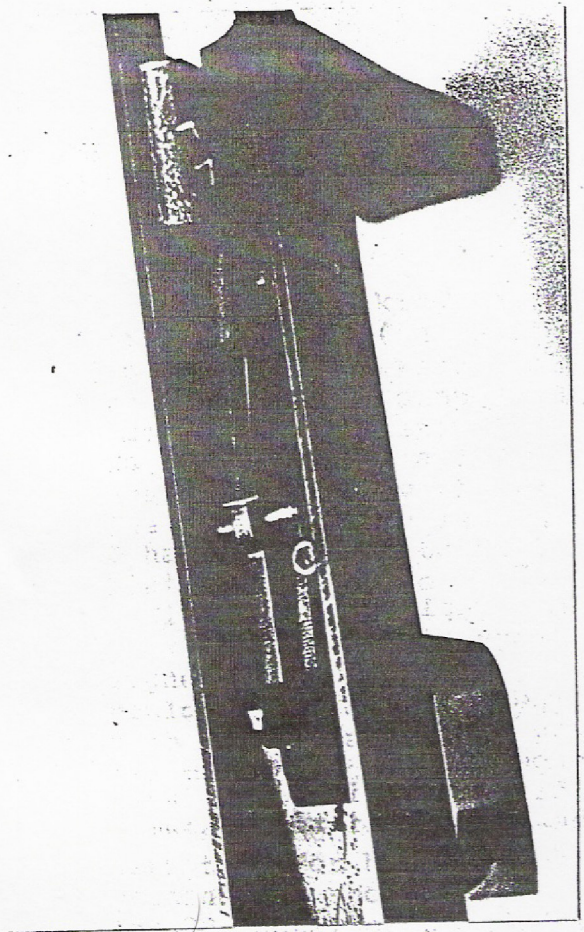

Sear

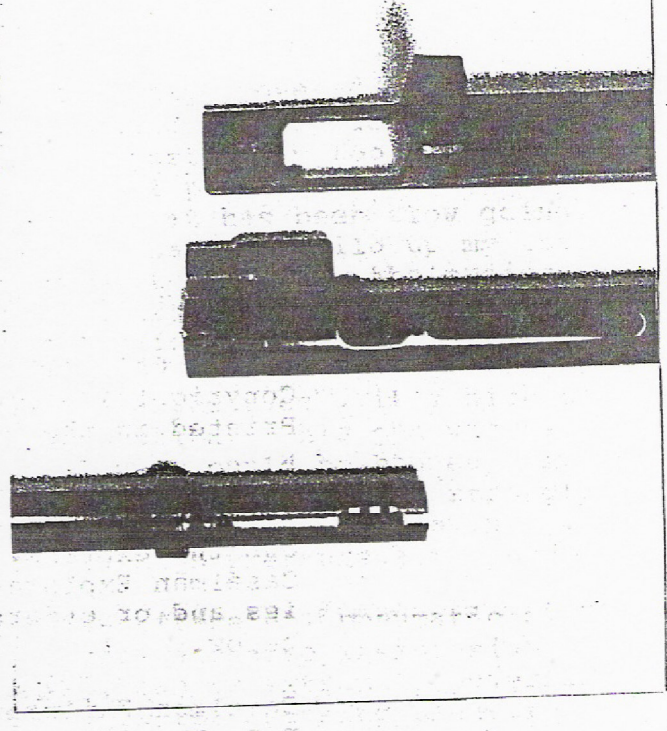

Barrel receiver + mag. housing

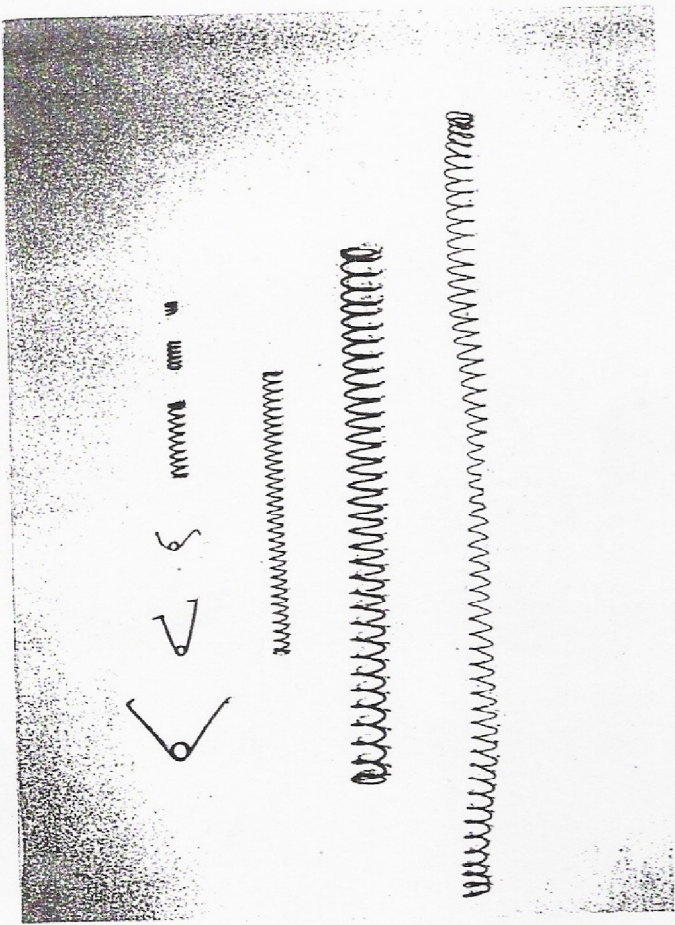

Springs

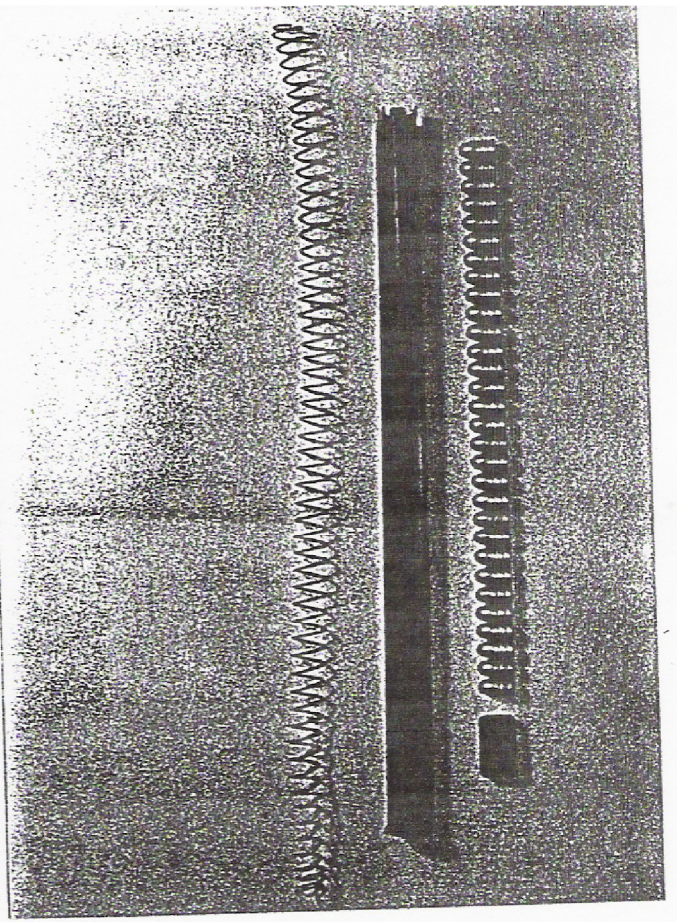

Magazine assembly

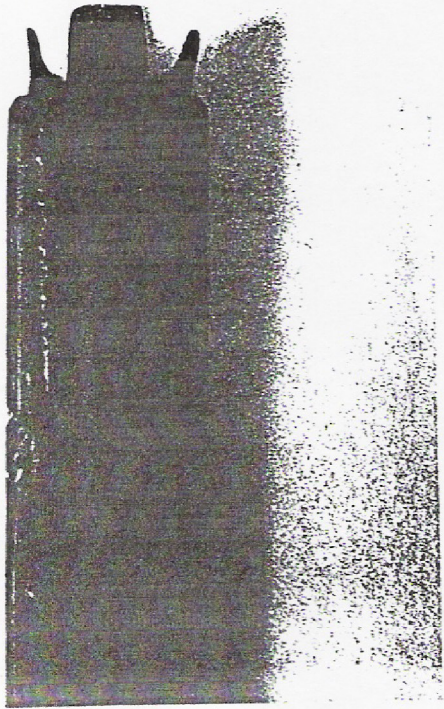

Magazine end

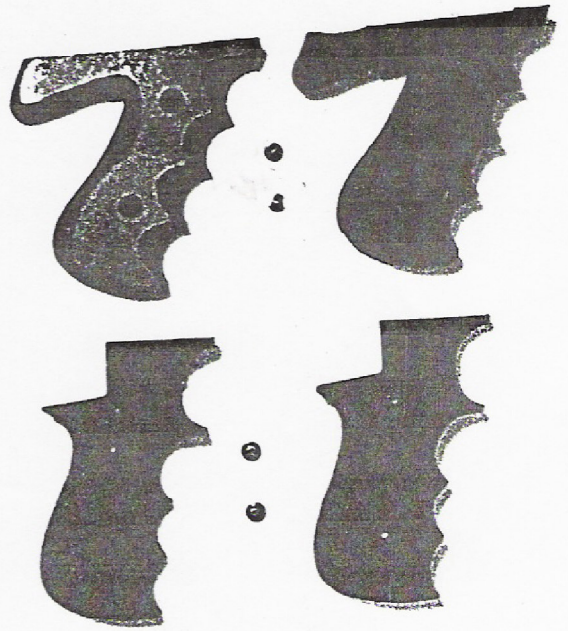

Magazine end

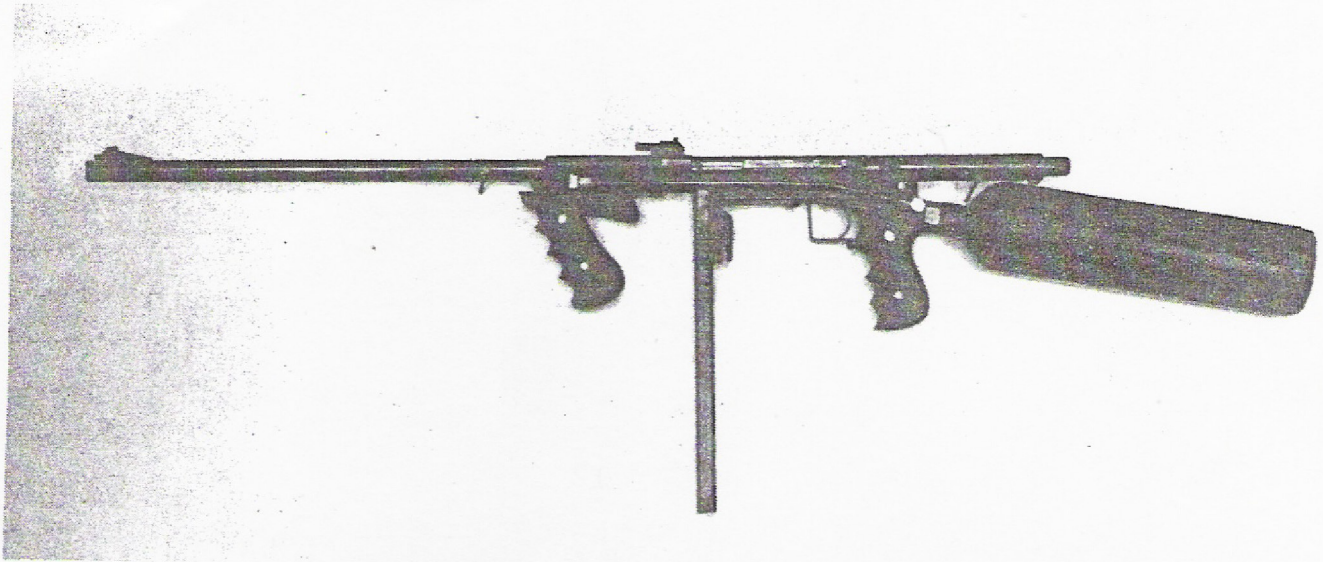

With gun prohibition staring us in the face...it's nice to know you don't have to be without protection. This gun was designed with the idea that any and all guns could be banned, ammo could be illegal or unavailable. That's why we strongly urge you to have the plans. To have the security of knowing you can make a high powered automatic with high pressure air, and mold your own bullets. It is a **self-sufficient alternative for home protection & defense**, and also **inexpensive machine gun shooting and enjoyment**.

This gun is a basic **blow back system** designed to operate from a **pre-pumped detachable tank** of approx. 100 cu. in capacity, which is the shoulder stock. It can be extremely powerful for 30 shots, or tuned down to 150 shots for shooting pleasure. Pressure drops slightly from shot to shot, but our valve design tends to compensate for it. **There are many sources of air:** dive shops, divers tanks, small DC compressors from military surplus, air craft strut pumps and shop built hand and motor driven two and three stage pumps. Liquid CO2 is 1000 lbs. of pressure at 83 degrees, and as long as there is a liquid portion in the tank the pressure would remain the same at 83 degrees. (Although 1000 lbs. of pressure would be low for higher velocity's.) This would give several hundred shots per tank and it could be refilled from a fire extinguisher. The gun has a **30 round detachable magazine**, with a bullet mold selected to cast a 1 in 40 parts tin bullet. It is a **selective fire** with a **two stage trigger**. The first stage is **semi-auto** and the second stage is **full-auto**. This alternative weapon can be built on a lathe with a milling attachment and basic shop tools, and **will saw off a 2x4 at 25 yards!**

Although the engineering has been long in the making, we now have a totally new concept in air gun shooting. The complete detailed plans reveal this awesome new design for \$19.95 with the instruction and performance video only \$59.95.

The 30 caliber air machine gun was individually handmade, although any and all parts may be ordered at an hourly shop rate from:

CASELMAN EXPLORATIONS, BOX 348, CAMERON, MO 64429

A recent reply we received writes: "I found your design very simple and powerful."

PLANS OFFER:

OUR MACHINE SHOP ASSISTANCE ON ANY OR ALL PARTS
RAW MATERIAL KITS
COMPLETE MACHINED KITS
MAGAZINES
BULLETS AND BULLET MOLDS
LIGHTWEIGHT TITANIUM TANKS
CALIBER CHANGE FORMULAS
VELOCITY FORMULAS
CONSTRUCTION AND PERFORMANCE VIDEO
NEWSLETTER OF THINGS TO COME

CASELMAN EXPLORATIONS

BOX 348
CAMERON, MO 64429