

DIY .38 Caliber Revolver Plans

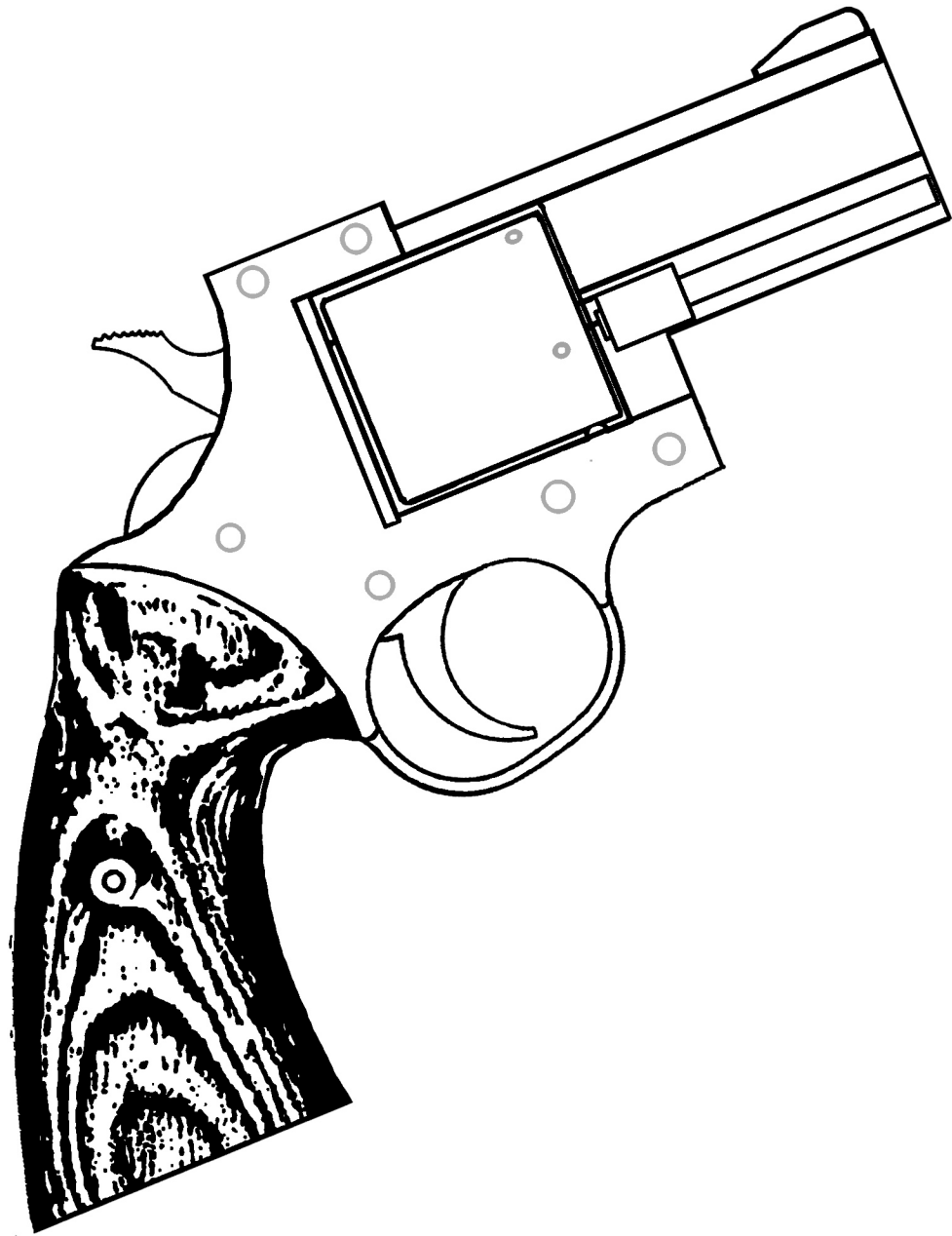

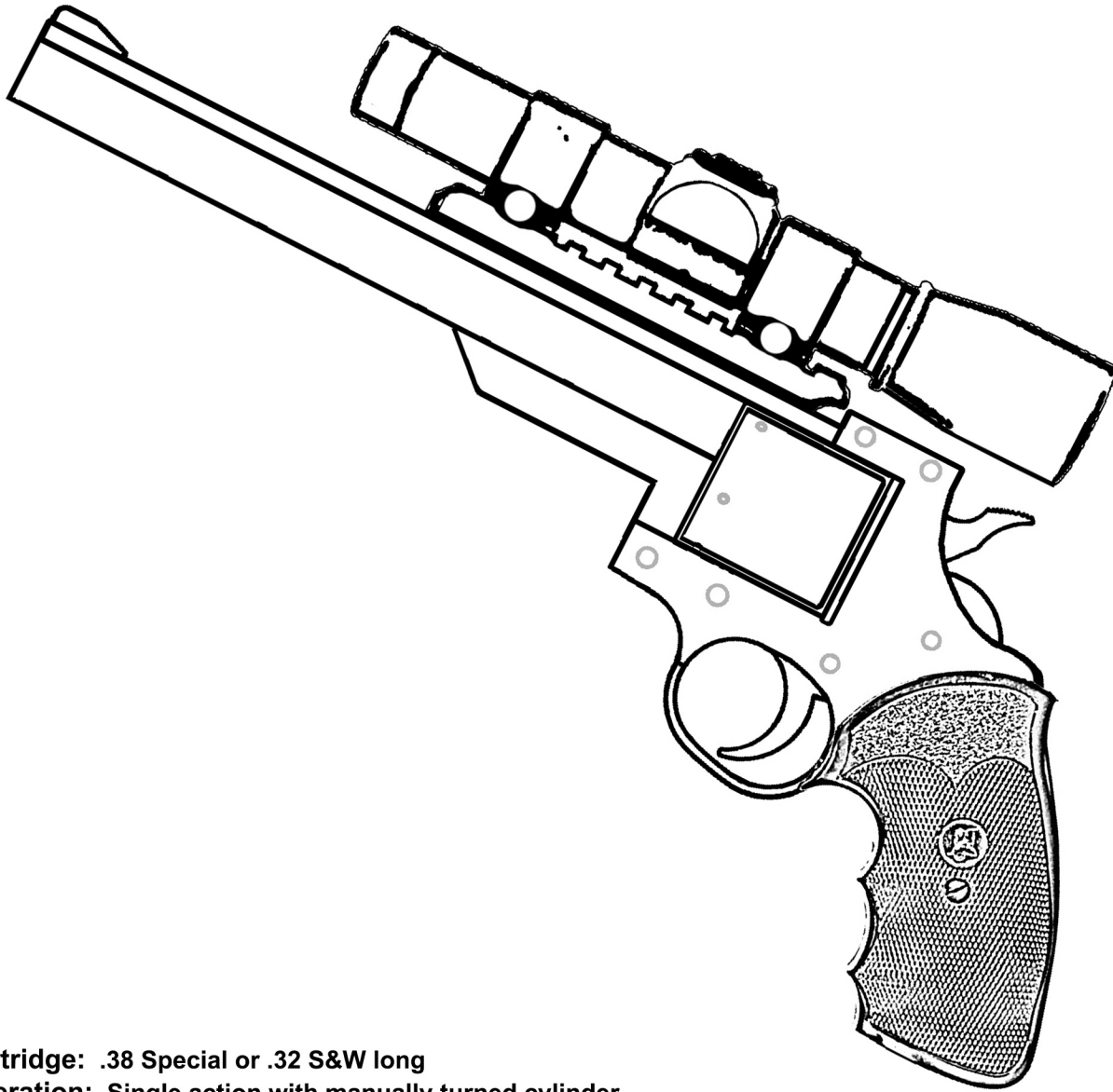

Cartridge: .38 Special or .32 S&W long
Operation: Single action with manually turned cylinder
Barrel length: 2.5" to 8" swappable unit
Capacity: Five shot

All pages included should be printed out on 8.5 x 11 US letter paper. Each component template is drawn to scale and can be cut out and glued to their respective thickness of material or used as a reference for measurements. Make sure the ruler at the bottom left of each sheet is 2 inches in length. Alternatively, take a screen-shot and enlarge the plans using a computer program until the ruler is the correct length, then trace the parts needed onto a sheet of paper taped over your computer's screen.

Grip frame templates

1/4" (6mm) wide mild steel strap, 1/8" (3mm) thick

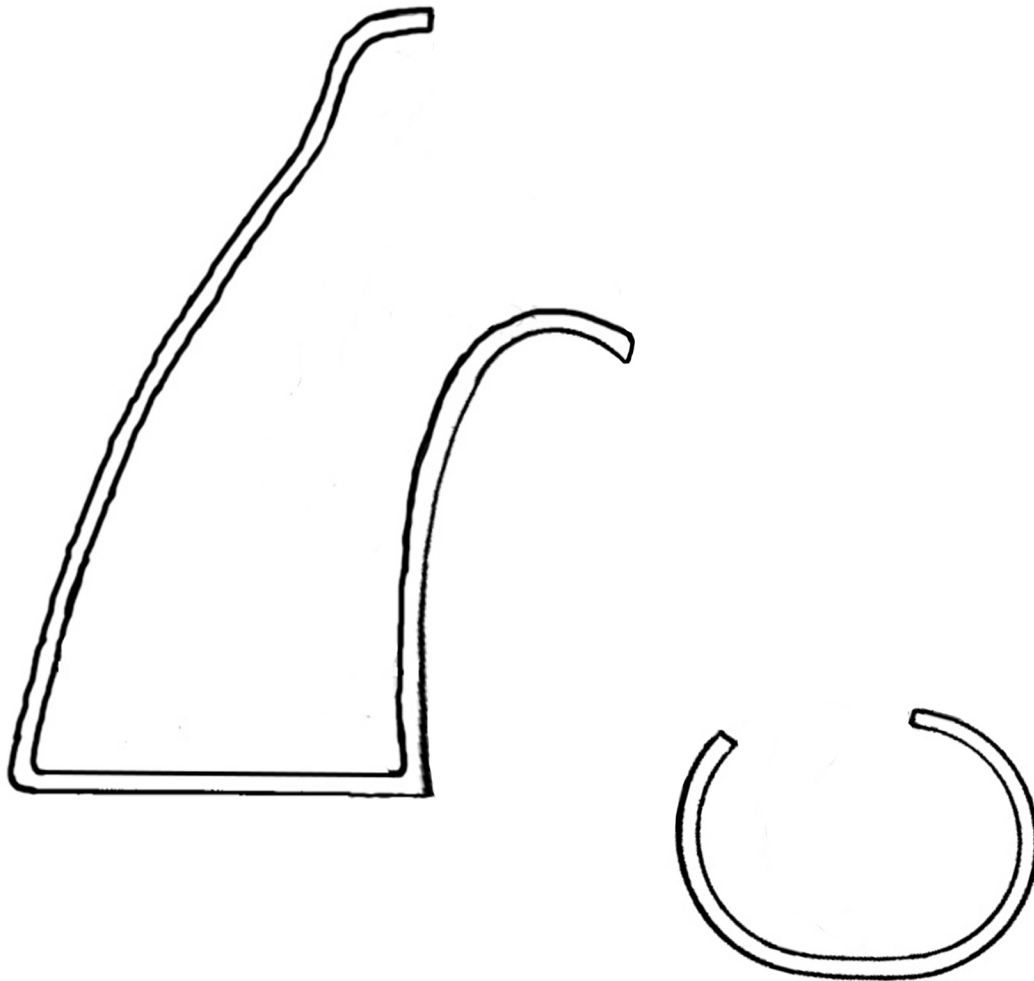

Spring holder (1/8" steel plate)



2 inches

Print on 8.5x11 US letter paper

Grip frame assembled

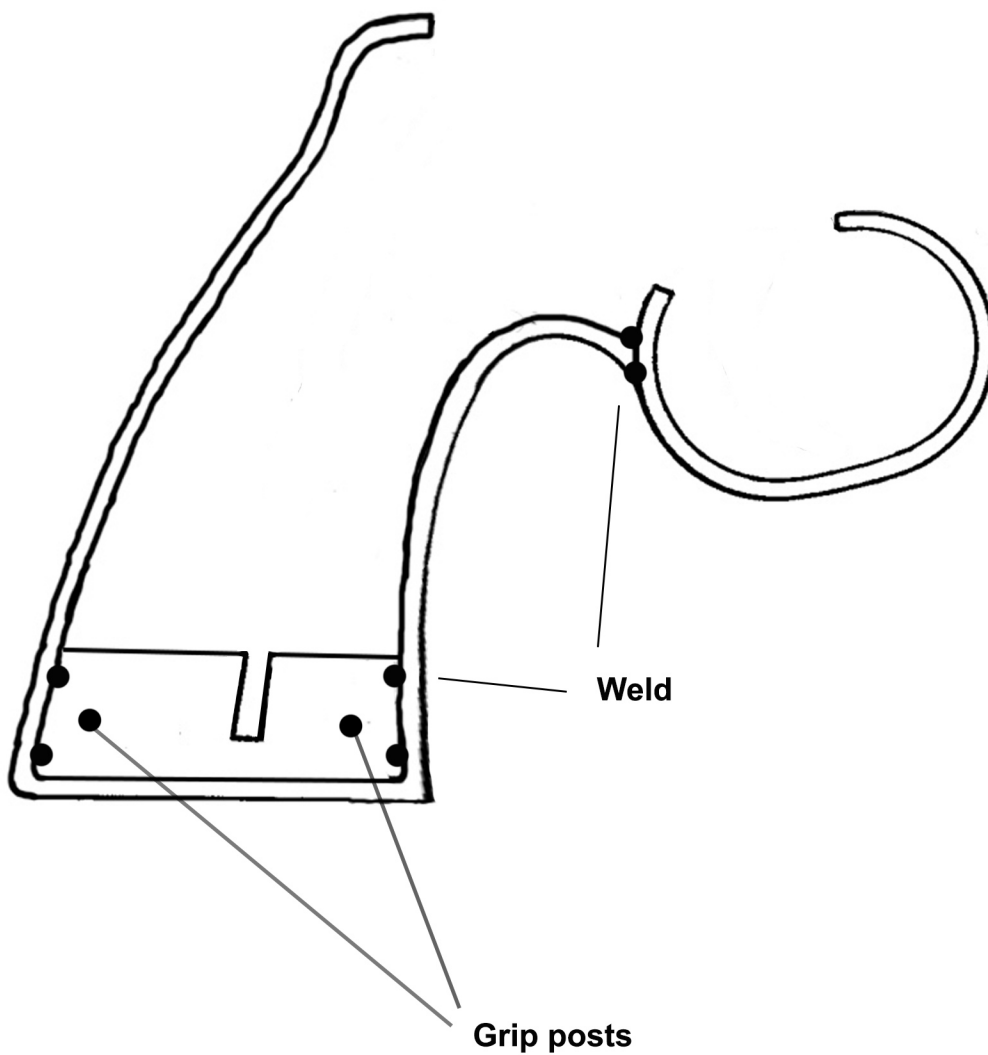

Drill and weld in two 15mm long 4mm dia pins. Drill out according locations on grip panels.

2 inches

Print on 8.5x11 US letter paper

Frame side plates

1/8" (3mm) mild steel plate

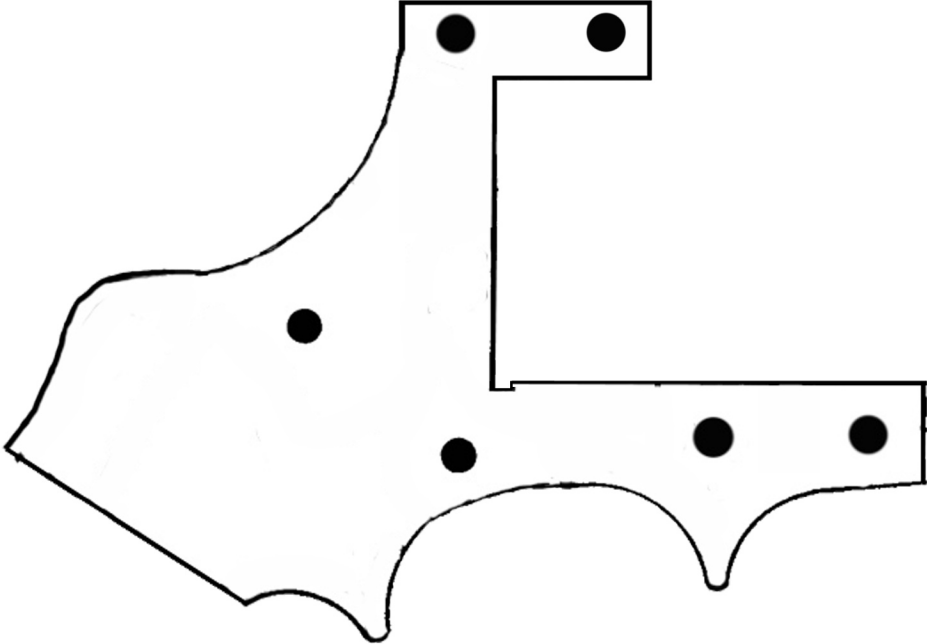
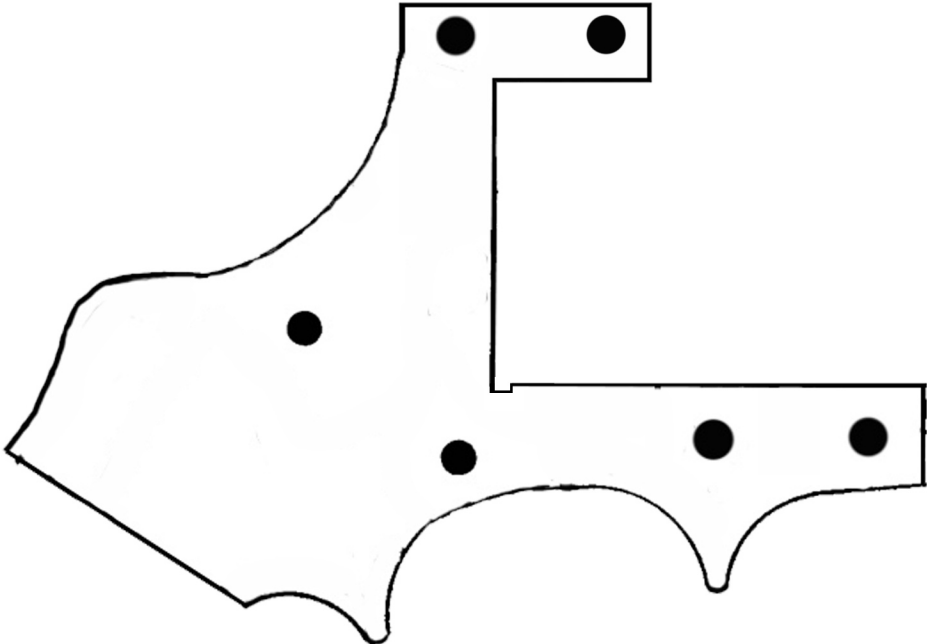

2 inches

Hammer & trigger

Cut from 1/4" (6mm) steel plate

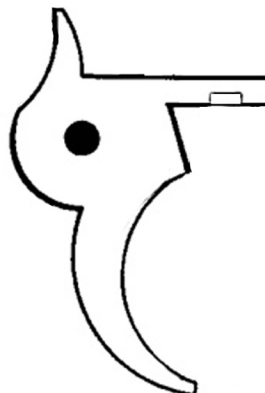
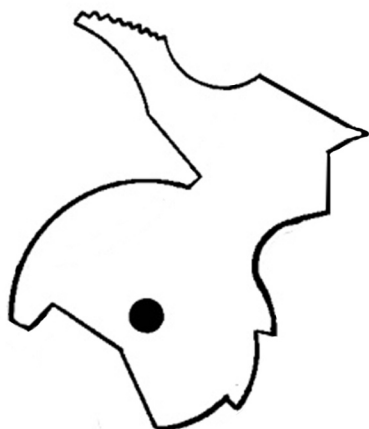

Trigger spring
(4mm x 10mm)

File profile of firing pin to a 'pyramid' point



Heat hammer & trigger until cherry red and quench using Kasenit to harden

Main spring

Made by stacking together 3 strips cut from a handsaw blade

6mm

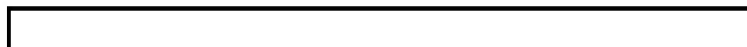

100mm

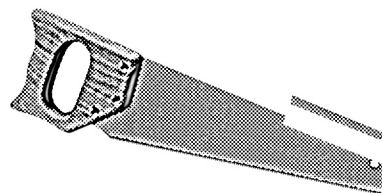

2 inches

Print on 8.5x11 US letter paper

Left side plate is welded to grip frame & trigger guard. The right side plate will remain removable.

The hammer and trigger post holes are both drilled with a 3mm bit and tapped to accept an m4 bolt with epoxy applied to the threads. Each bolt is then beheaded to create two 9mm high fixed pivot posts. Alternatively use two 12mm long 4mm dia pins and weld over bottoms from left side.

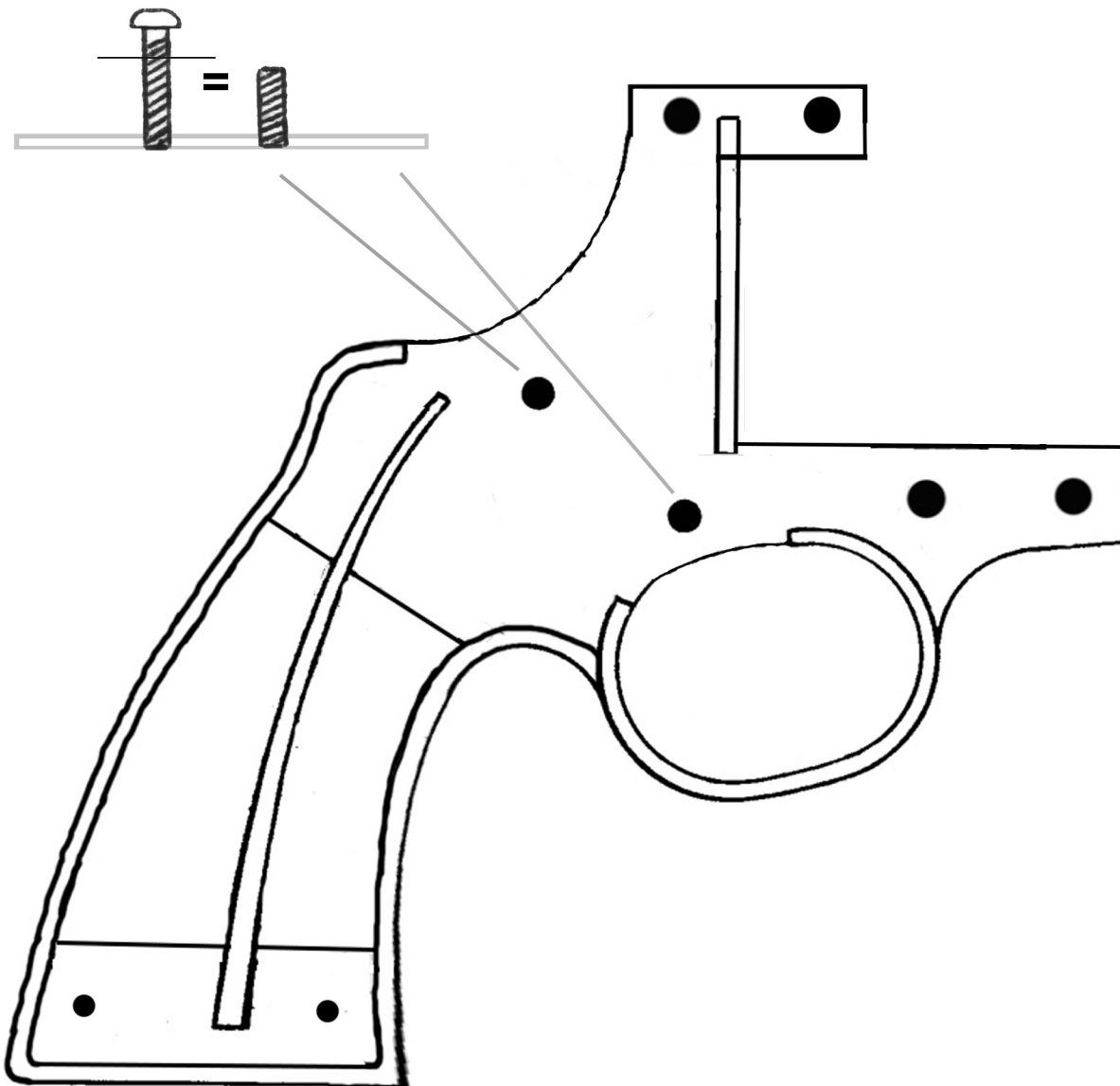

2 inches

Cylinder

.38 Special

1.5" (38mm) steel round bar, 40mm long

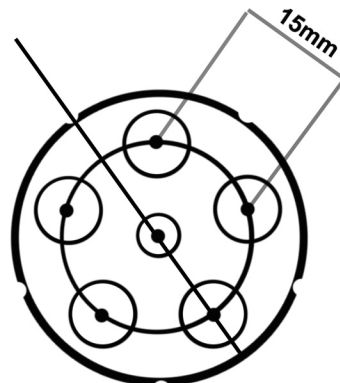
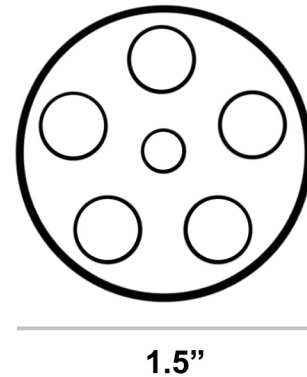
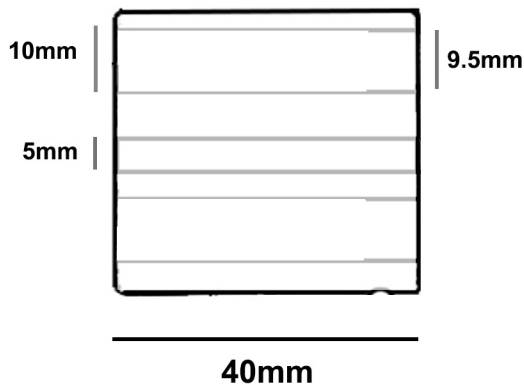

- Set a compass to .500 (1/2") from the center and scribe an inner circle.
- Mark a point on the inner circle line and following a clockwise pattern mark 15mm from each point until each chamber position is located.
- Each chamber hole is drilled using a 9.5mm bit and chambered 33mm deep using a 10mm bit.
- Indexing points are aligned opposite each chamber, 10mm from front of cylinder. Produce a shallow dent at each point using a 3mm bit.
- Drill through center using a 5mm drill bit for cylinder pin.

For .32 S&W Long, drill through chamber holes using an 8.2mm bit and chamber using an 8.6mm bit, 22mm deep.

2 inches

Breech plate

Cut from 3mm thick mild steel plate

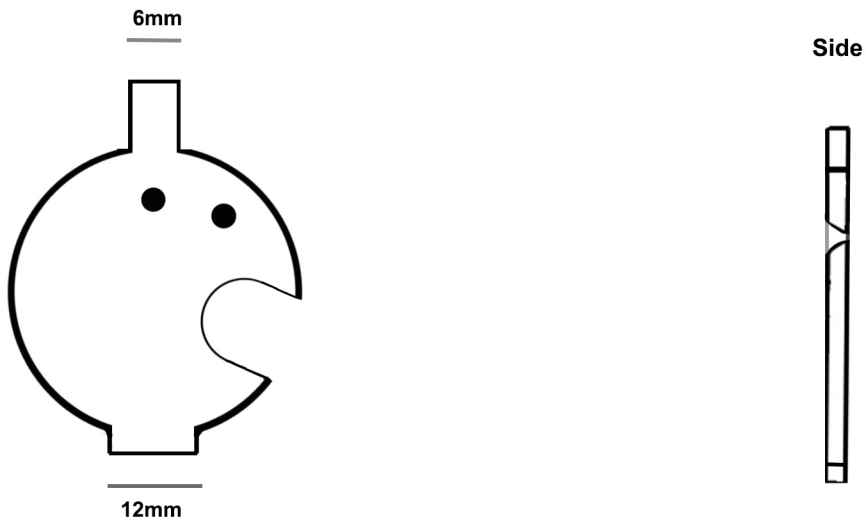

Drill firing pin hole using a 4mm bit and enlarge vertically using a rotary tool + small grinding bit.

Loading port cover

Cut from 2mm or 3mm plate.
Secure using an m4 bolt tapped into breech plate.



2 inches

Print on 8.5x11 US letter paper

Frame assembly

The breech plate should be firmly held in place by both frame plates + top strap of barrel.

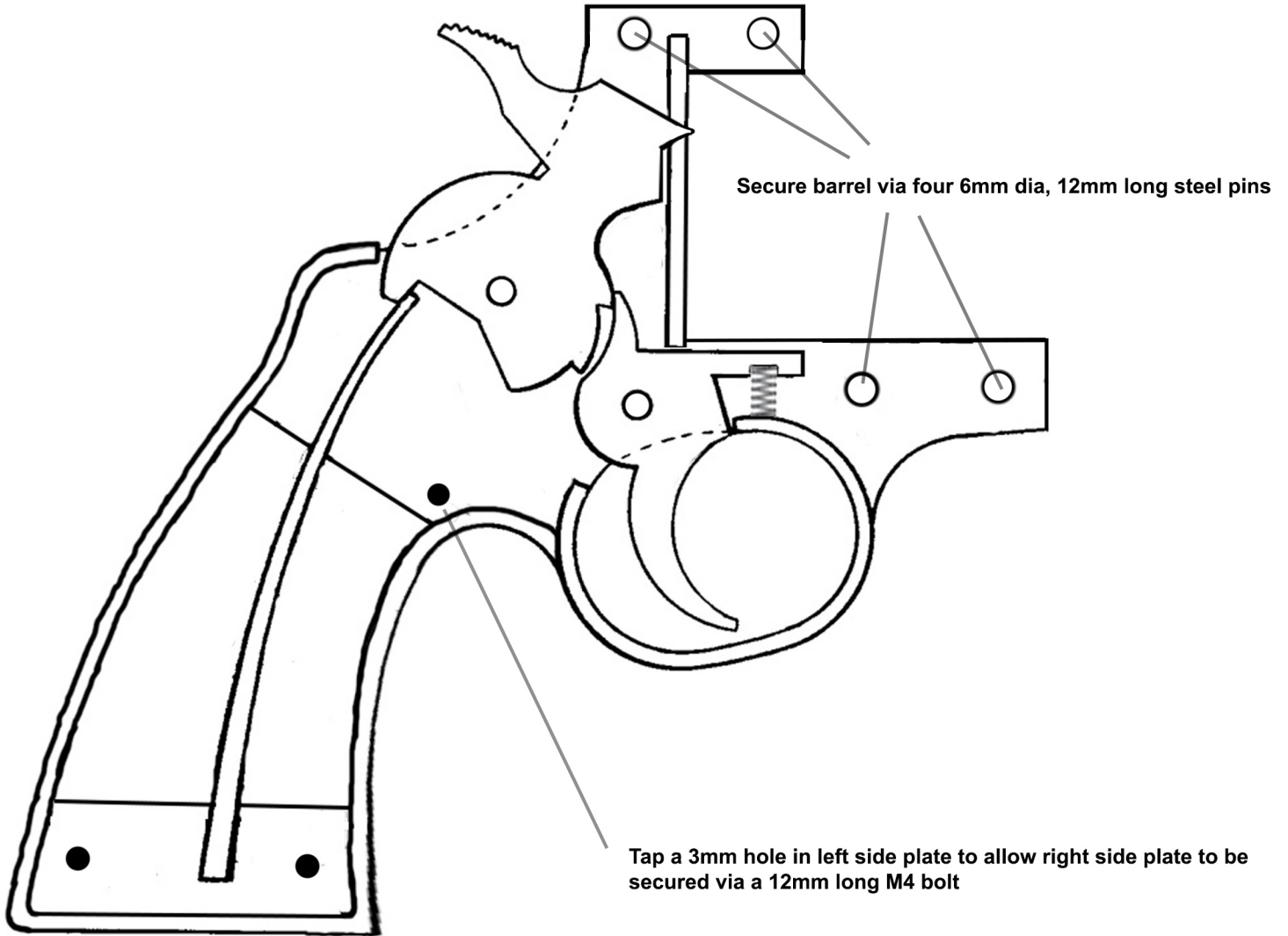

2 inches

Print on 8.5x11 US letter paper

Barrel

.38 Special: 16mm dia, 3.5mm thick wall seamless steel tube (9mm ID).

.32 S&W Long: 16mm, 2mm wall tube sleeved with 12mm, 2mm wall tube (8mm ID).

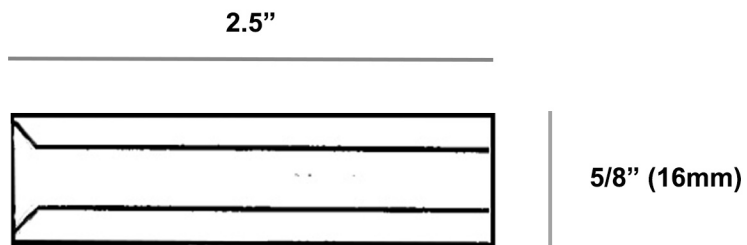

Form a large forcing cone
using a taper cutter or 16mm+ drill bit

Templates

Bottom

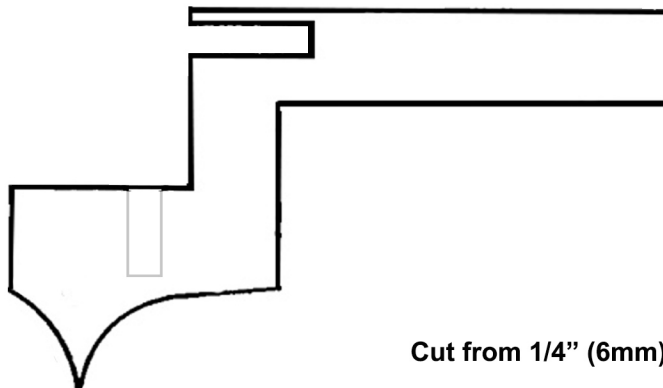

Cut from 1/4" (6mm) thick mild steel plate

Top strap

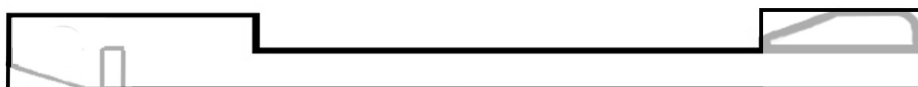

2 inches

Top strap (Finished profile)

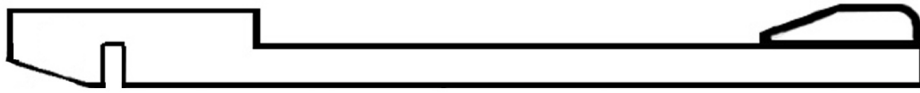

Front



Back



Cylinder pin

5mm dia steel bar, 53mm long
(Weld in place)

Drill 3mm dia hole for spring and detent. Thread bottom
and counter sink for a 4mm long M4 bolt.

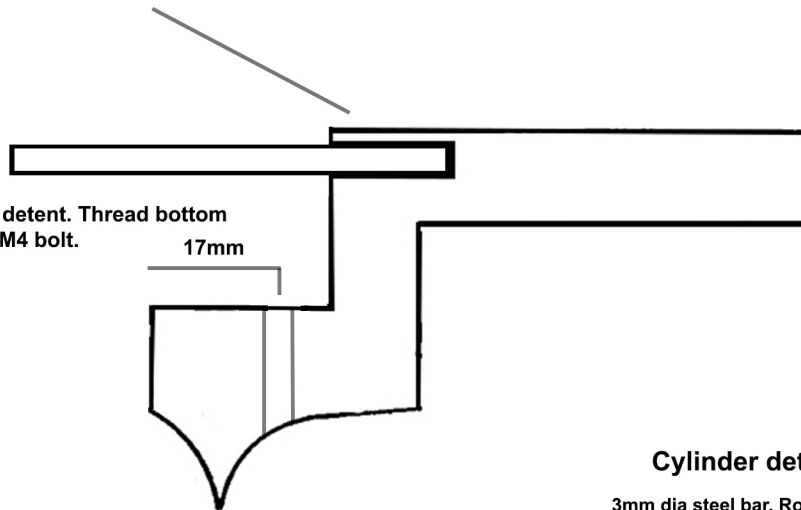

Cylinder detent

3mm dia steel bar. Round off top.



3mm

Detent spring can be obtained by dismantling a retractable pen

2 inches

Print on 8.5x11 US letter paper

Barrel assembly

Weld a substantial bead along all four contact points with barrel. Smooth down with an angle grinder + flap disc.

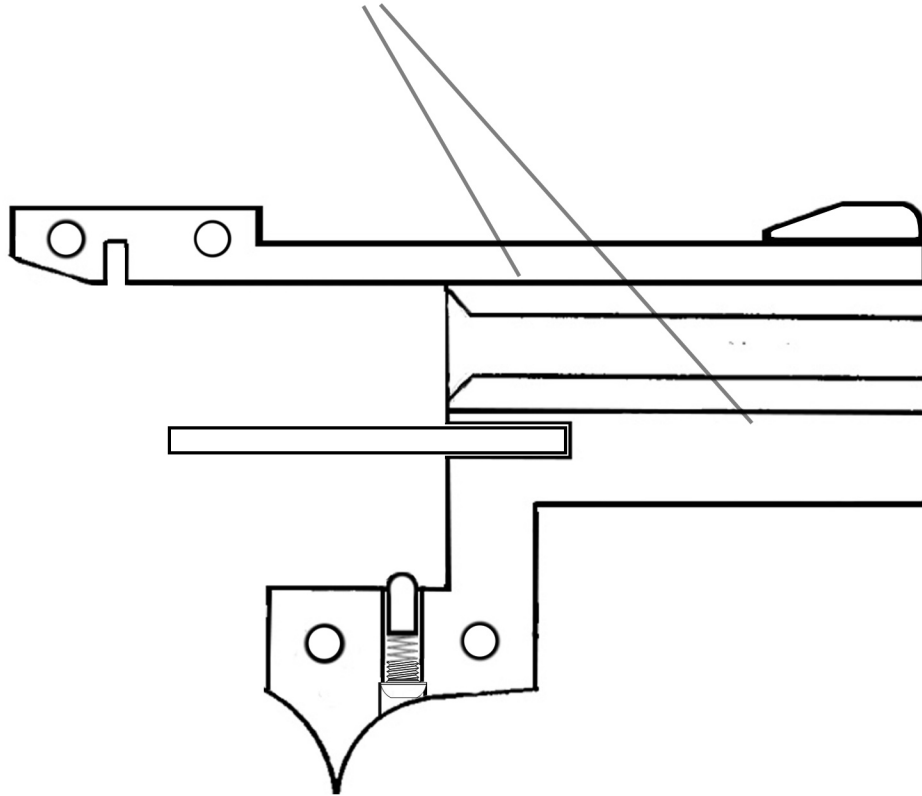

2 inches

Print on 8.5x11 US letter paper

Cylinder alignment

Insert a 6" length of 9mm dia bar through barrel and into a chamber on the cylinder. Using the detent hole on the lower frame as a guide, lower a 3mm drill bit through it and drill out a small dent into the position (now locked) on the cylinder wall. Repeat the process for each of the five chambers. Thread detent hole and secure with an m4 bolt counter sunk into lower frame. If completed correctly, the spring loaded detent will produce a ratcheting friction lock when the cylinder is turned.

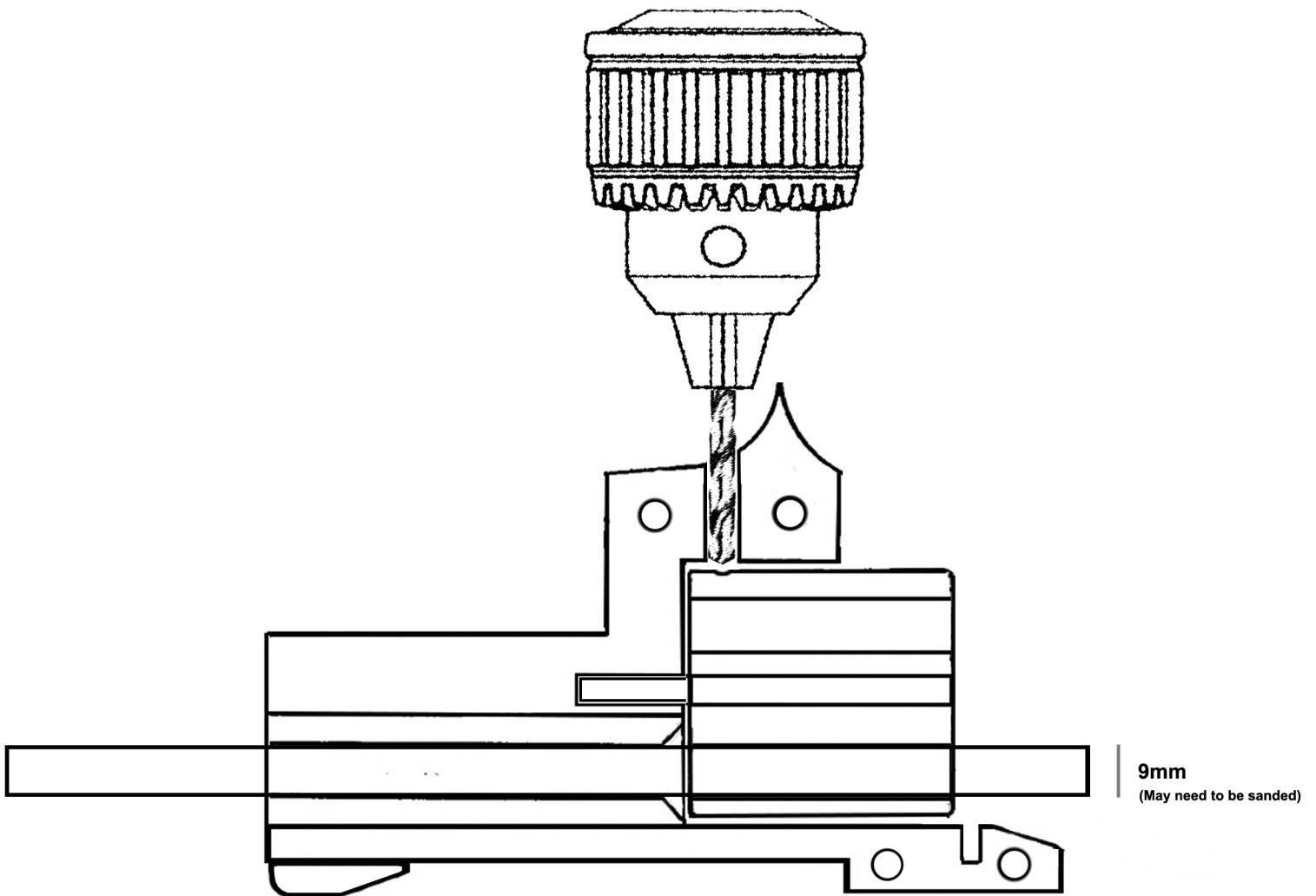

2 inches

Cartridge ejector

Rod holder

10mm x 2.5mm steel tube or drill out a section of 10mm or 1/2" dia bar.



Rod

5mm dia steel bar. Once inserted in holder, slightly 'mushroom' ends using a hammer to permanently captivate.

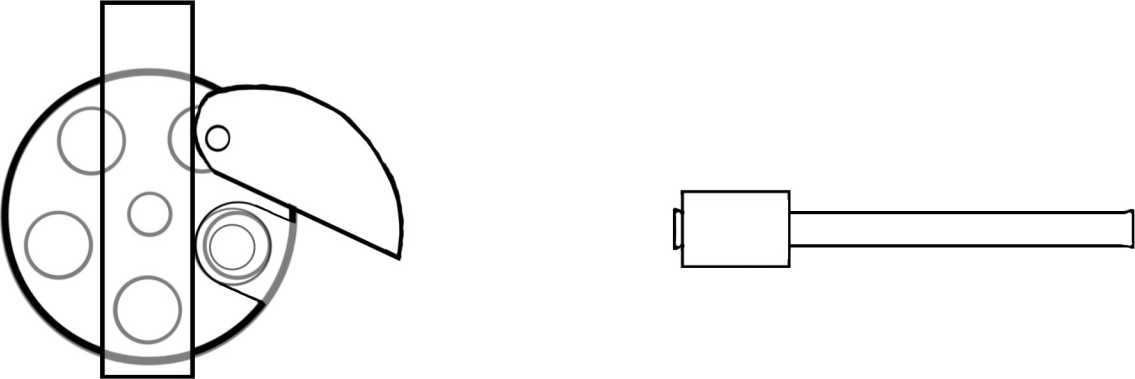
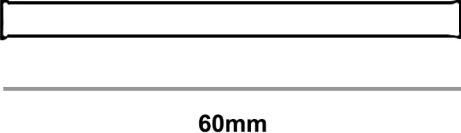

Weld holder section of assembled ejector in line with loading port.

2 inches

Grips

1/2" hardwood

Epoxy an M4 nut into one of the bolt holes and secure together using a 1 1/2" M4 button head bolt. Perform final shaping while assembled to frame.

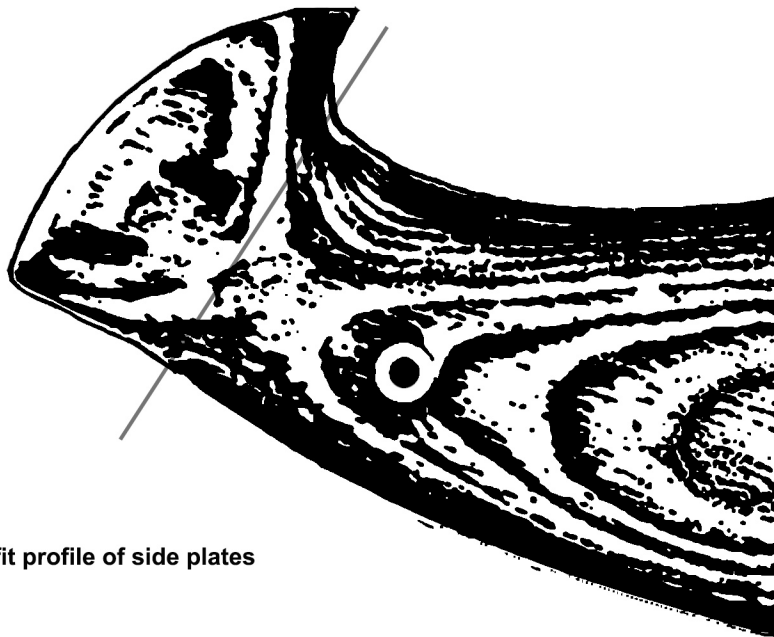
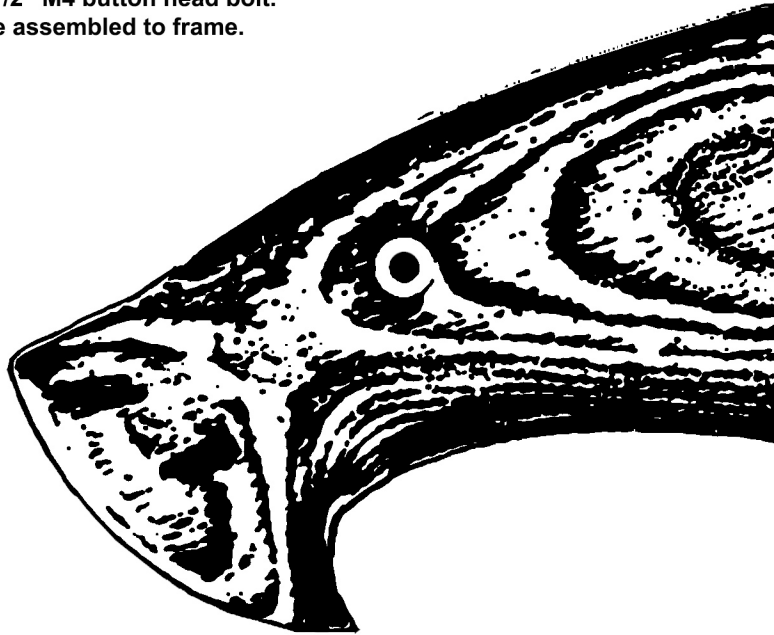

File off 3mm of undersides to fit profile of side plates

2 inches

Print on 8.5x11 US letter paper

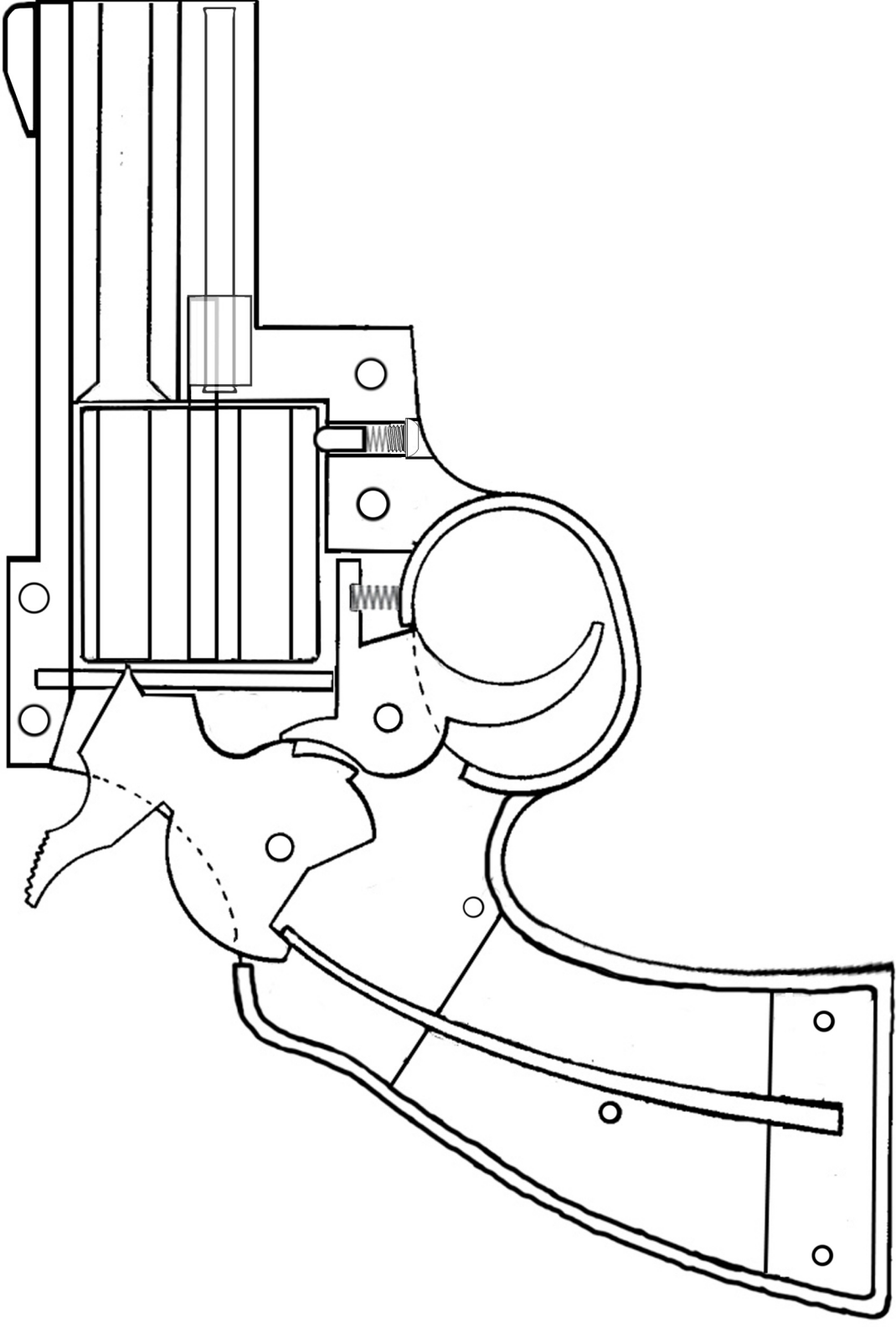

2 inches

Print on 8.5x11 US letter paper

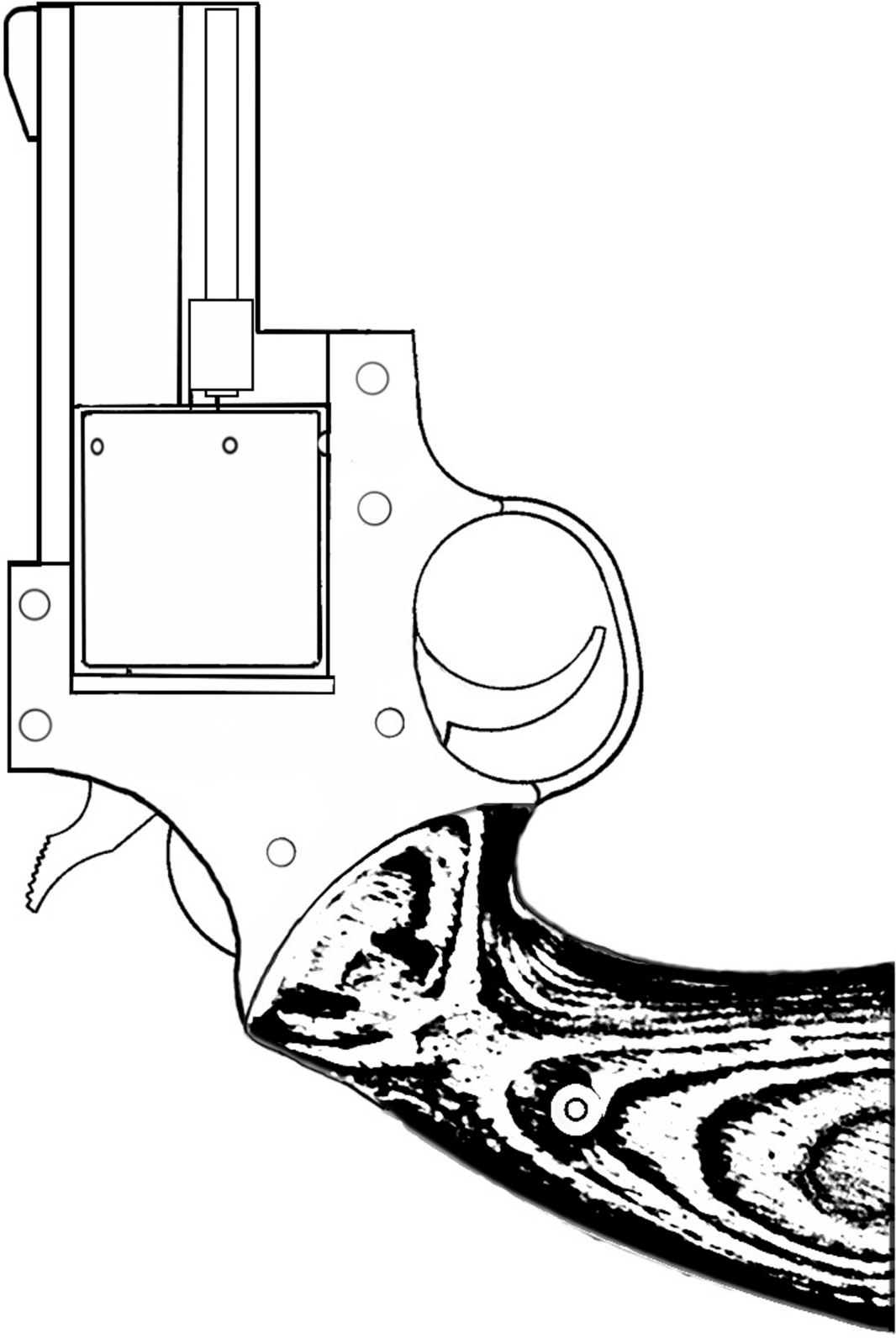

2 inches

Print on 8.5x11 US letter paper

