

### Extractor

Bend from 28mm long strip of 5mm wide steel (2mm thick) to profile below

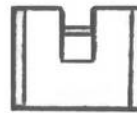

Top

# The Box Tube MAC-11

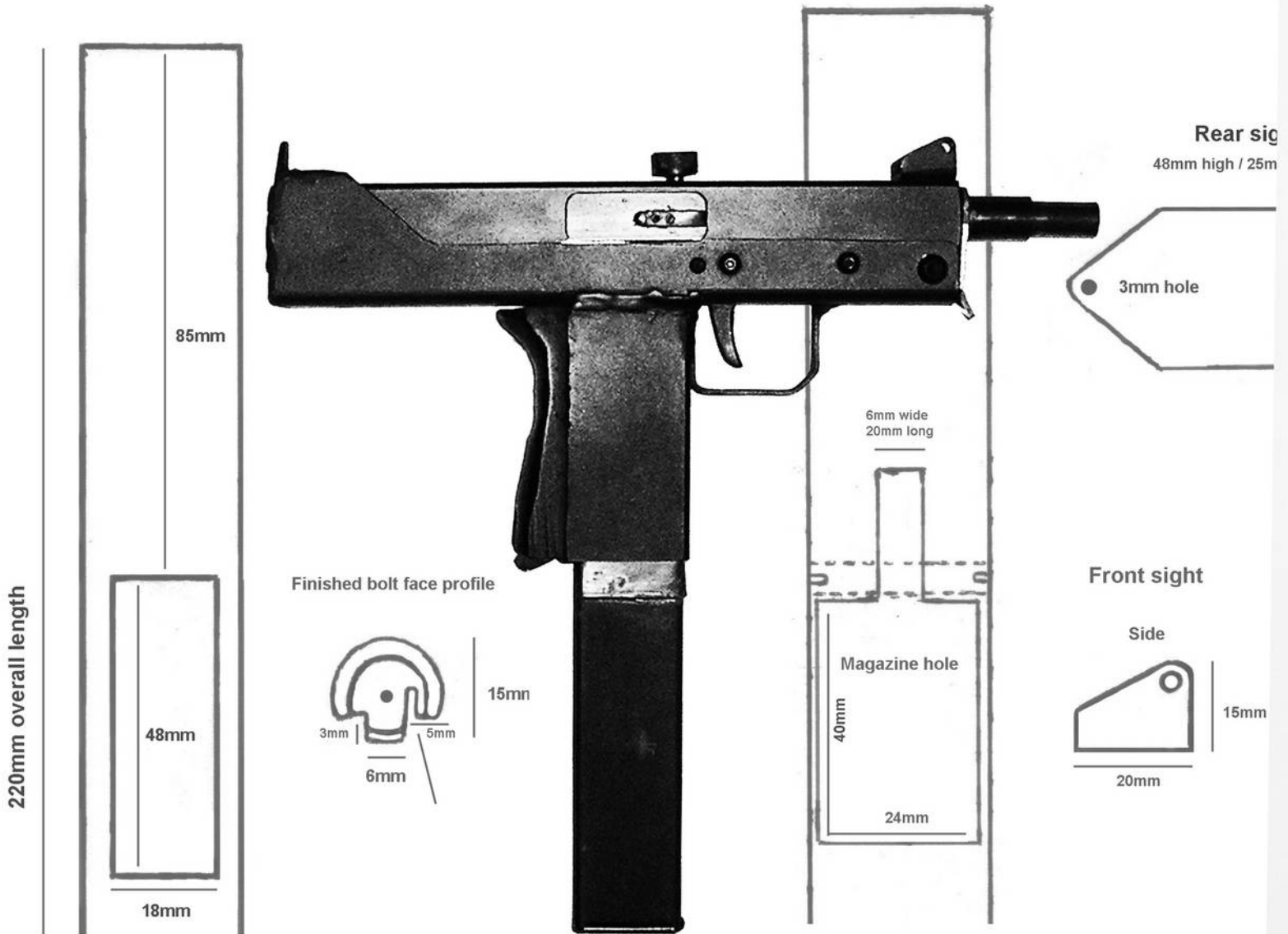

## The Ultimate DIY Machine Pistol

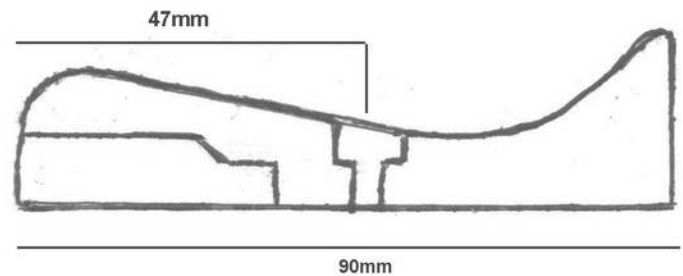
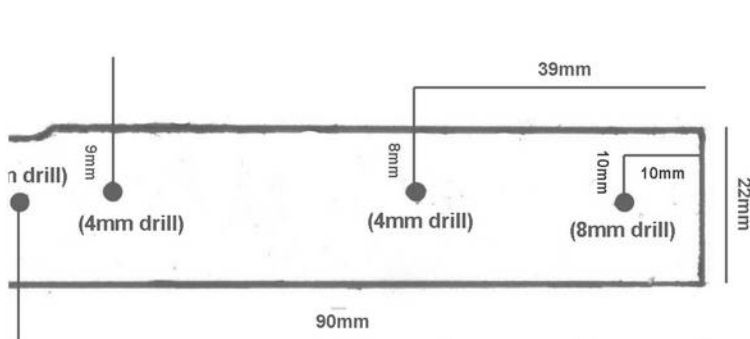

# **The Box Tube MAC-11**

*The Ultimate DIY Machine Pistol*



**Practical Scrap Metal Small Arms Vol.II**

By Professor Parabellum

## Introduction

The machine pistol described here is perhaps the most compact of any homebuilt design publicized. In its outward appearance it is an almost 1:1 clone of the M11-9, probably one of the most desired submachine guns in existence due to its highly compact size and mainstream notoriety. It uses minimal parts and is as simple to construct as any typical homebuilt design, yet matches an original commercially made gun in looks, function and quality. The small nature of the design lends itself ideally to .32 ACP, though additional weight can be added to the bolt through the use of lead or tungsten weight inserts.



With the original weapon already having a highly refined receiver layout, the development stage focused solely on simplifying both the bolt and fire control mechanism to negate the use of a well equipped workshop for production, as cloning the original would require. The resulting weapon is externally identical in size to the original with the main differences being the method of constructing the bolt and its fire control group consisting of two easily constructed components. Construction has also been simplified by using measurements in-line with the upper receiver, as is present on most open bolt submachine guns such as the STEN and Sterling. This negates having to offset the position of the breech face and barrel trunnion as replicating the original M11 would require. By altering the design in this manner, every component housed in its upper receiver can be made by simply laminating two sizes of tubing and steel bar stock together.

Another 'get around' incorporated into this design is the simple two part assembly of its wrap-around type bolt. This component is constructed by combining a section of 16mm steel bar stock fitted with a length of 30mm x 2mm steel box tube. By laminating in this very simple manner the need for a milling machine to mill the bolt from a single block of steel is eliminated.

*For legal purposes, the demonstration prototype shown in this publication was built as a legal non-firing dummy replica. Its dummy barrel is completely destroyed, blocked and permanently welded in place as well as its bolt being built out of specification and having no provisions for a firing pin. Built in this manner it is not legally considered a firearm in most places. **This document is for academic study purposes only.***

## Tools & construction techniques



### Force PT110921 4-1/2-Inch Angle

**\$19.99** from 3 stores

7.5 Amp, 11,000 rpm motor designed for fast material removal

*An angle grinder – The Poor Man's Milling Machine*

No expensive machine-shop tools are needed to construct the Box Tube MAC-11. Instead a number of very affordable tools can be used to the same effect. Equipped with a cheap angle grinder the average hobbyist has the ability to perform machining actions usually reserved for an expensive milling machine. Rather than tediously using a hacksaw to cut steel sheet, an angle grinder fitted with a 1mm slitting disc will accurately cut a straight line through steel of any thickness in mere seconds. Fitted with a 2mm disc it can be used to easily 'sculpt' thick steel into any shape in a fraction of the time it takes to manually use a hand file. Importantly for this project it is used to grind the magazine cuts in the bolt piece after which a hand file can be used to neaten the newly created 90 degree channels. This technique works surprisingly well and it's not unusual to get very neat right-angle cuts which look as though they were produced using a milling machine. One can manufacture almost any component of any weapon using this technique in very short order with very pleasing end results.



*Small arc welders like the one above are available cheaply for purchase over the Internet*



### Force 1.1 Amp Rotary Tool Kit

**\$13.98**



The Force 1.1 Amp Rotary Tool Kit is an essential tool for homeowners and c

A rotary tool or dremel is highly useful for delicate grinding and cutting operations. Fitted with a 'reinforced cutting disc' it becomes a mini angle grinder, ideal for cutting out and grinding openings in pieces of tube quickly and neatly without having to manually use a hand file. These can be purchased cheaply online with a large variety of cutting, grinding and sanding bits available for working with metal.

With enough patience it is possible to construct every component described using only a drill, hacksaw, and a few hand files. However, for under \$100 you can purchase all the budget tools necessary to complete the project in only a couple of afternoons. It is well worth venturing to any 'swap meet', 'car boot sale' or 'flea market' as all tools mentioned can be found practically being given away in used condition.

## Useful tools

**Angle grinder**

**Hacksaw + cobalt tipped blades**

**Cobalt or titanium tipped drill bits**

**Drill press or hand drill combined with a stand**

**Welder**

**Dremel / rotary tool + reinforced cutting discs**

**Hand files**

## Materials

- 1" x 2" (50mm x 25mm x 1.5mm) mild steel box section**
- 1" (25mm x 25mm x 2mm) mild steel box section**
- 1 1/5" x 2" (30mm x 50mm x 2mm) mild steel box section**
- 13/16" (20mm x 20mm x 2mm) mild steel box section**
- 3/8" (10mm) thick aluminum or steel plate**
- 14 gauge (2mm) mild steel plate**
- 5/8" (16mm) round or square mild steel bar stock**
- m3, m4, m8 bolts**
- 3/4" (18mm / 19mm diameter) compression spring**

**If excess tightness is encountered, square tubing can be reduced in OD slightly on each side by using an angle grinder fitted with a grinding or sanding disc.**

## Overview of components and their construction

### Lower receiver



The lower receiver is cut out from an 11.6" / 295mm long length of 30mm x 50mm steel box section tube with a wall thickness of 2mm onto which the trigger group, rear support bar, magazine and front lug holes are made. The rear closure is bent to the specified dimensions and is welded in place with the rear sight plate welded over it. A 'U' shaped strip of 2mm sheet metal serves as a trigger guard and is welded in place. The rear support bar holds the upper receiver firmly in position with the rear closure portion of the lower receiver while the front lug holes allow it to be secured in place.



A section of 1/4" (6mm) thick aluminum or steel plate is cut to shape and serves as a feed ramp. It is secured in place by tapping it to accept two m3 bolts.

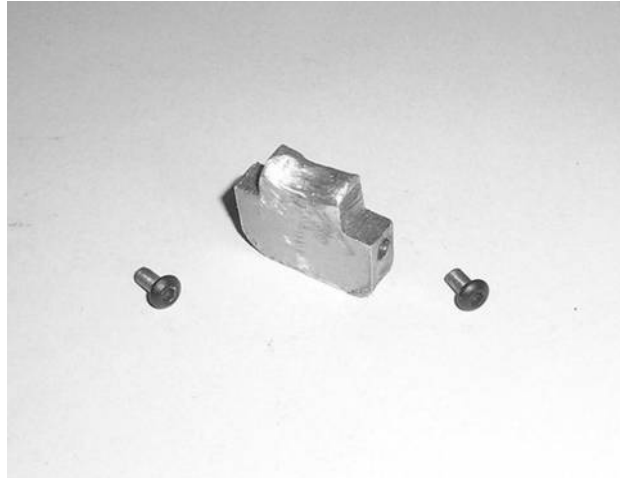

### Upper receiver



The upper receiver is constructed from a length of 25mm square steel box section with a wall thickness of 2mm onto which the ejection port, cocking handle slot and lower opening sections are cut out. The best method to achieve this is to use a combination of drilling holes around the inside section to be cut out before cutting along the holes using a dremel type rotary tool fitted with a 'reinforced cutting disc'. These are extremely durable and can be used to neatly grind the edges to shape without having to use a hand file. If a dremel is unavailable, a hammer and a screw driver can be used to chisel out the drill hole lines after which a hand file can be used to file down the edges. A front lug made from a piece of the same 25mm box section is welded or bolted onto the lower front end and holds the upper receiver in place. This same material is also used for the construction of the front sight.

## Barrel



The demonstration model pictured was made with a non-functioning dummy barrel which is permanently destroyed (blocked by a hardened steel insert and cut open) and is welded in place. In this configuration it is not considered a firearm and can be legally owned and built freely as a display replica in most places.

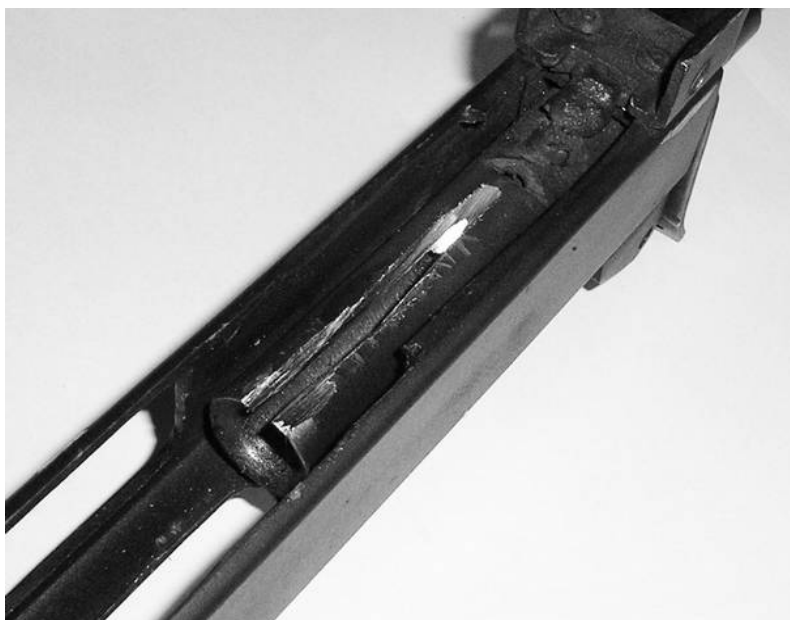



The outer dimension of the barrel is 5/8" (16mm). This fits tightly into a section of 20mm x 2mm round tube or square box section which serves as a collar to attach the barrel to the upper receiver. The barrel is secured in place either by welding or by means of a pin installed across the upper receiver as is present on the original MAC design.

## Magazine-well

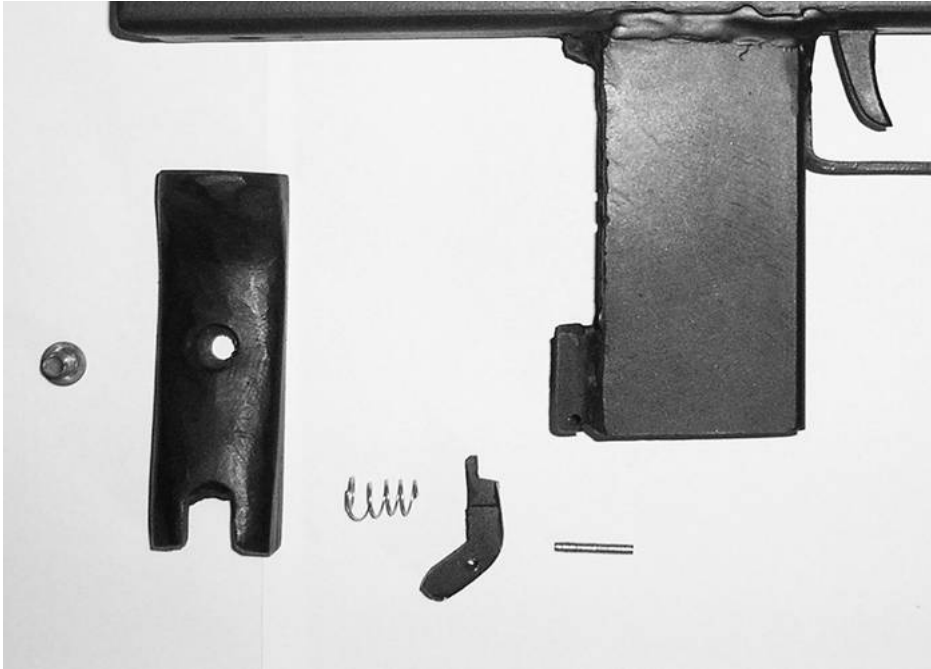

The magazine-well is made from a section of 1" x 2" (25mm x 50mm) steel rectangle tube shortened to 25mm x 43mm by removing, widening slightly, then re-welding one 25mm side to allow snug contact with the magazine. The magazine catch is cut out from 10mm aluminium plate, it's housing consisting of a small piece of bent steel sheet or rectangle section welded in place. The back grip piece is cut out from either wood or plastic and is drilled to accept an M5 bolt to attach it to the magazine well. Once completed the magazine-well is welded to the lower receiver. If a welder is unavailable, an alternative method would be to use an 'L' shaped piece of metal to secure the magazine-well to the bottom of the receiver using two short bolts.

The example shown uses a modified STEN magazine which has had the stop lips ground off and a new stopper attached. Alternatively, a homemade magazine constructed from 15mm x 35mm tube can be used. In this case a length of 20mm x 40mm steel tube with a wall thickness of 2mm is all that is required for it's magazine-well. A magazine-catch can be as simple as a length of handsaw blade combined with a modified nut and bolt.

## Bolt



For legal purposes, the bolt on the demonstration model was made without provisions for a firing pin and can only feed dummy inert rounds. Rather than milling a bolt from a single block of steel, it is constructed by inserting a length of 16mm round or square steel bar into a length of 20mm steel square box section with a wall thickness of 2mm, the same material used for the barrel collar. The breech face of the bolt piece is first drilled 3mm deep using a 10mm drill bit (or 9.5mm for .32 ACP) and then levelled flat using the same size drill bit with its tip removed. The feeding cuts for the magazine are formed using an angle grinder fitted with a 2mm or 3mm grinding disc after which it is hand finished using a file. The ejector slot is cut using a 1mm slitting disc until the ejector itself slides in and out without resistance. The finished 'dummy' bolt is retained in place using a number of steel rods, grub screws or beheaded bolts threaded in place. Additional weight can be added by drilling out and inserting tungsten bars or partially filling the back of the bolt with lead. To ensure positive engagement with the sear, the contact point at the front of the bolt carrier can be increased in width using a welder and then filed to shape.

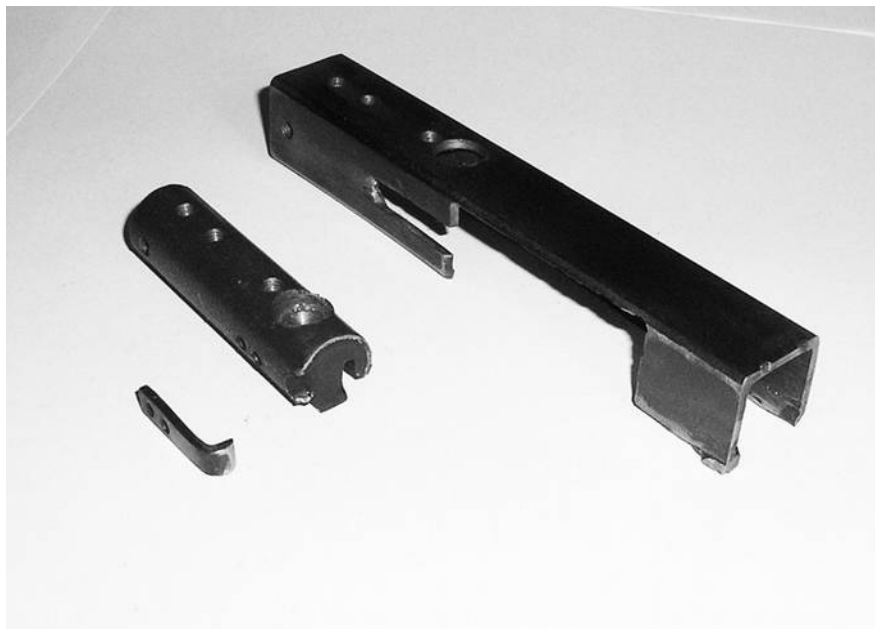

### Angle grinder milling:

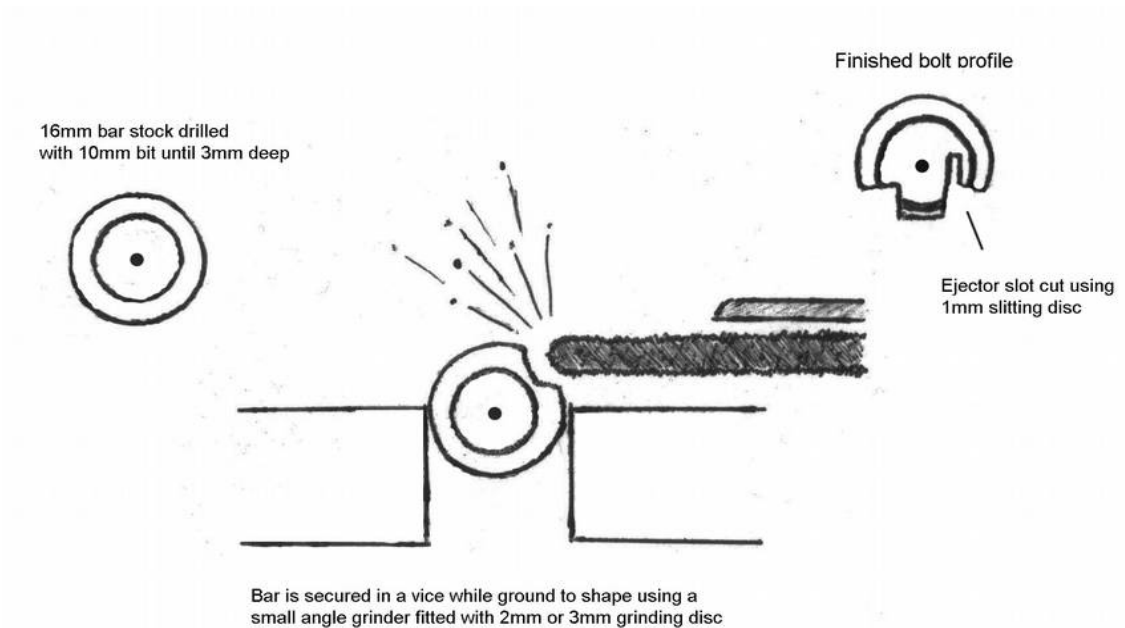

### Extractor



This machine pistol uses a fixed, spring-less extractor. Adding an extractor to a blowback design is usually optional, though the simplicity of this design hardly justifies leaving it out. In this case, it is simply a strip of 2mm sheet steel bent at a right-angle and filed into a simple claw profile after which it is then attached to the bolt via two m3 or m4 grub screws. Once confirmed functioning of the finished extractor claw is established it can be hardened by heating until red then quenching in a solution of salt water. The extractor claw should be made fairly undersized so as to allow a cartridge rim to easily slide into contact with it without interfering with feeding.

## Ejector

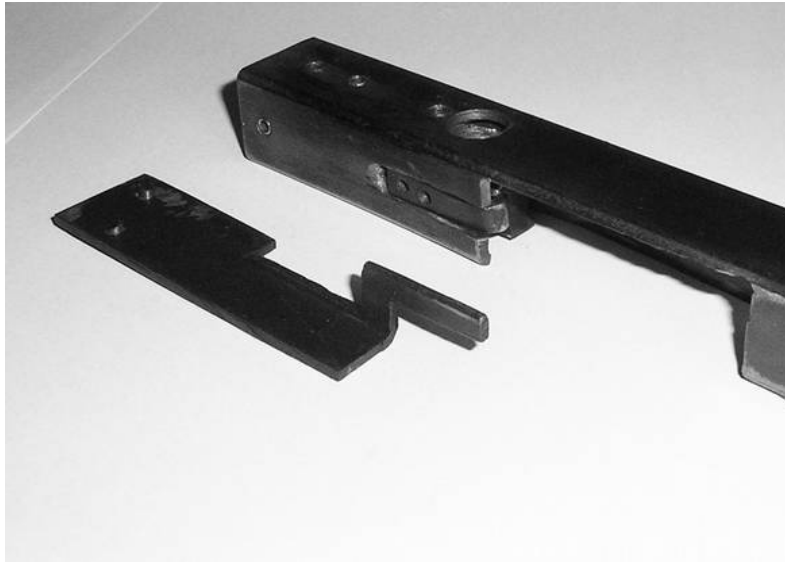

The ejector consists of a plate bolted onto the bottom of the upper receiver, its contact arm slotting up 90 degrees into line with the bolt's ejector channel. It is fabricated from a single piece of 2mm thick sheet steel. The plans provided contain a smaller simplified version.



## Trigger group



The trigger group consists of two pieces of modified 10mm thick aluminum or steel plate. The trigger is cut to the dimensions specified while the flat sear piece is cut out and fitted with a modified section of hardened/stainless steel bolt ground to it's required profile. This part makes contact with the front of the bolt carrier under spring tension, preventing it from moving forward until the trigger is pulled. A suitable sear spring can be obtained from a hand sanitizer or shampoo bottle.

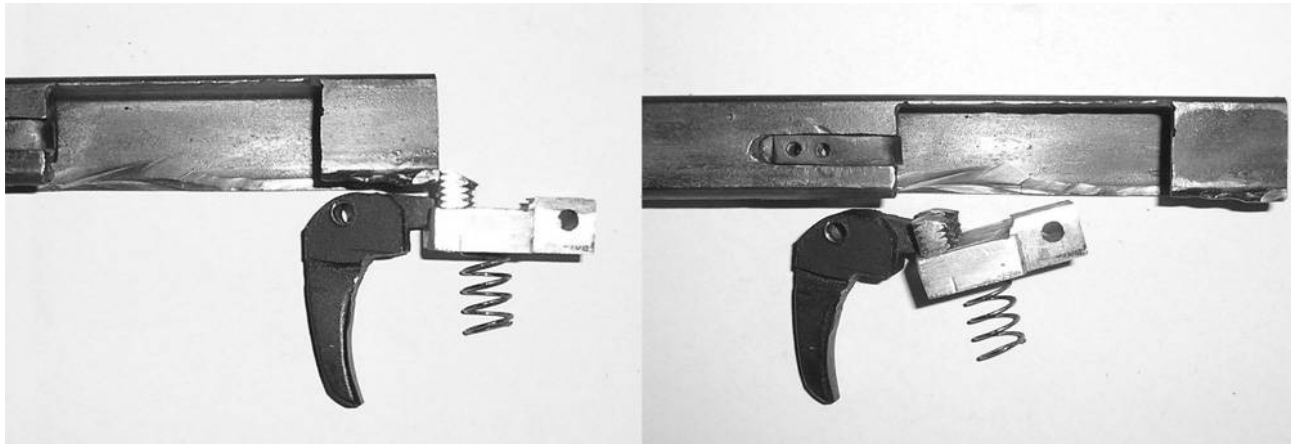

*Left: Cocked position – ready to fire. Right: Closed position – round chambered and fired*

## **Recoil spring**

Due to the small inner dimensions of the upper receiver, suitable compression springs are readily available for purchase online. A compression spring around 120mm (4 3/4") in length, 18mm (- 3/4") in outer diameter and wound from 15 gauge wire is desired. As long as a spring firmly holds the bolt closed and can be cocked back with a smooth and consistent pull, it will likely be suitable.

## **Magazine**

The demonstration model uses 9mm STEN magazines which have been modified by removing the original stopper tabs and instead fabricating a new stopper and catch notch. The magazine-well can optionally be slotted and the mag-catch increased in length to accept original unmodified STEN magazines. Plans for a .32 ACP / 380 magazine have also been provided.

## **Finishing**

Once completed the pistol can be stripped down and splayed with two to three coats of matt black High Temperature Engine Enamel. This type of finish usually requires no priming or preparation and is many times more durable than standard auto or BBQ paint.

## **Plans**

All pages included should be printed out on 8.5 x 11 US letter paper. Each component template is drawn to scale and can be cut out and glued to their respective thickness of material. Make sure the ruler at the bottom left of each sheet is 2 inches in length. Alternatively, enlarge the plans using a computer program until the ruler is the correct length, then trace the parts needed onto a sheet of paper taped over your computer's screen.

# Upper receiver

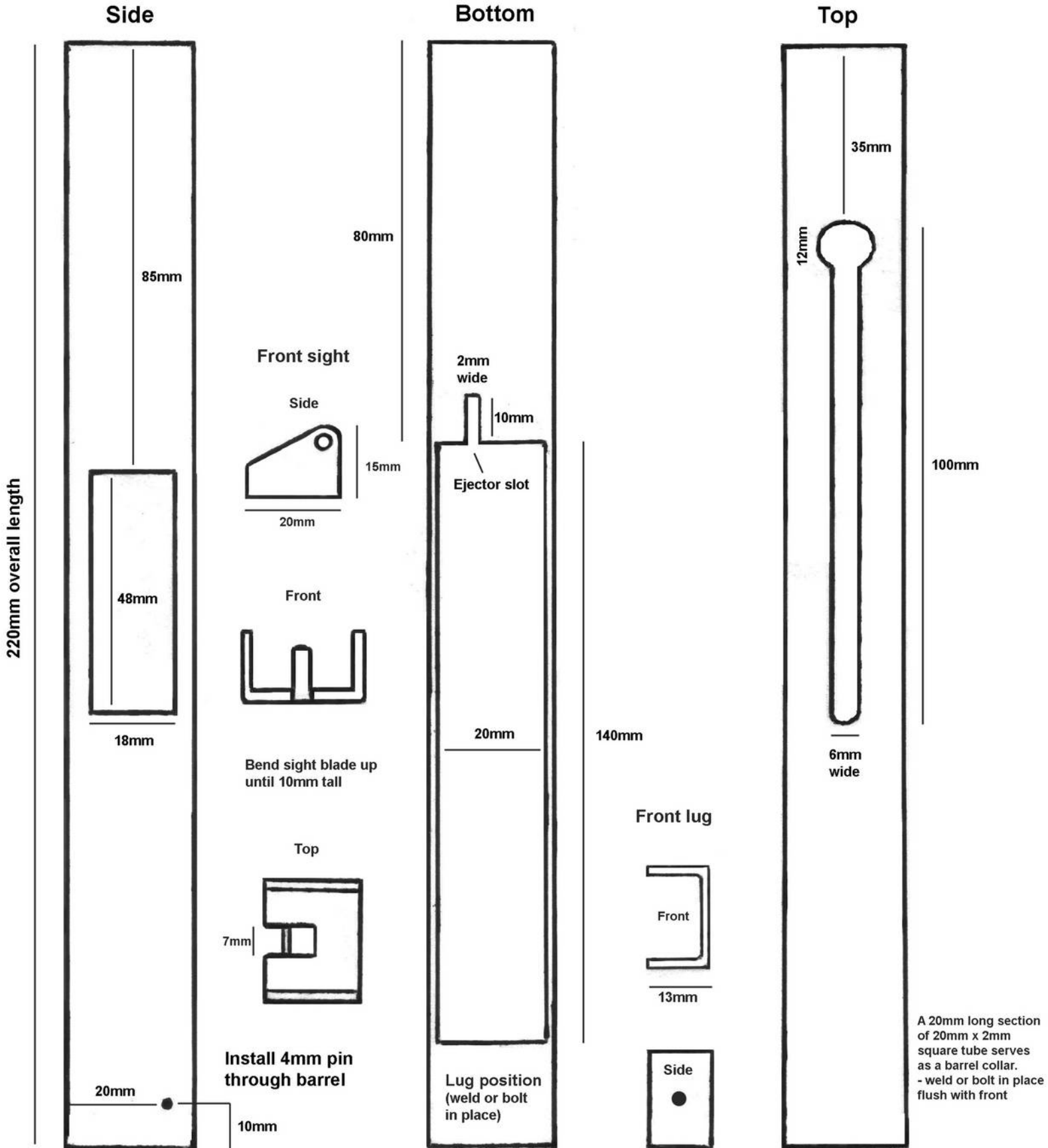

A 20mm long section of 20mm x 2mm square tube serves as a barrel collar. - weld or bolt in place flush with front

Cut lug from 25mm box tube - Drill with 7mm bit and tap to accept two m8 bolts

2 inches

# Lower receiver

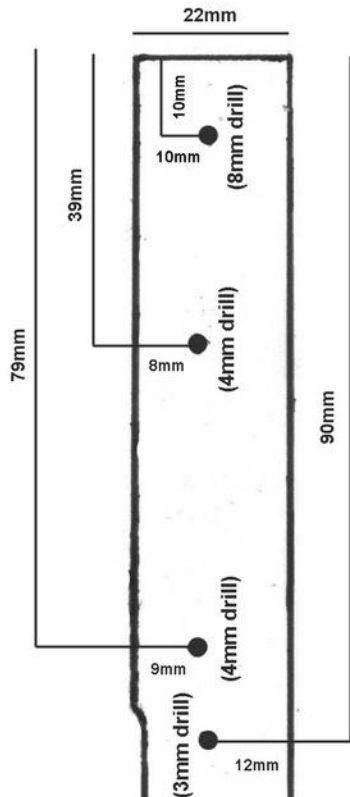

Cut from a 295mm long length of 30 x 50 box section

Overall length is 237mm long after rear portion is bent

Sides

Form remaining 60mm of bottom wall into 'L' profile

- Closure starts 231mm from front of receiver

Weld in place along top inner edges

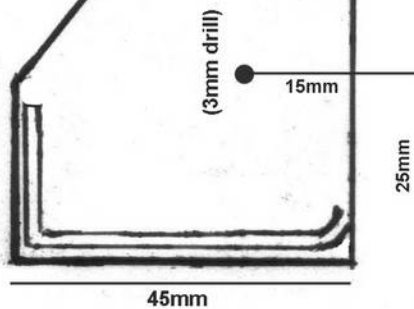

2 inches

Print on 8.5x11 US letter paper

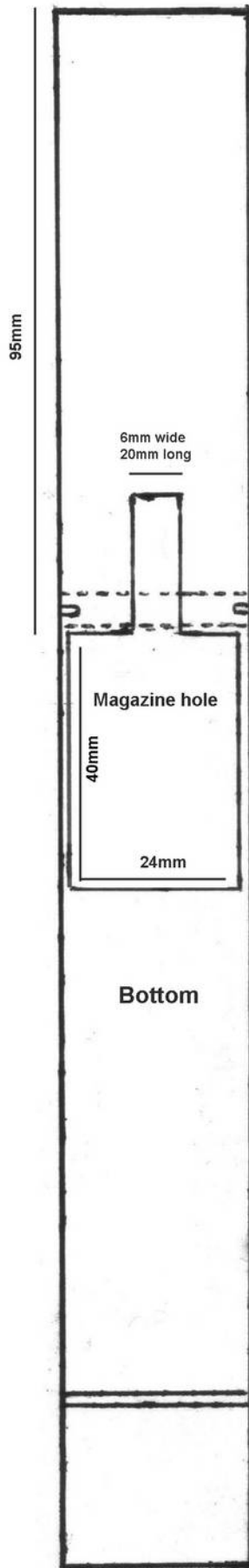

Position of feed ramp

## Trigger guard

Bend from 100mm long steel strip to profile

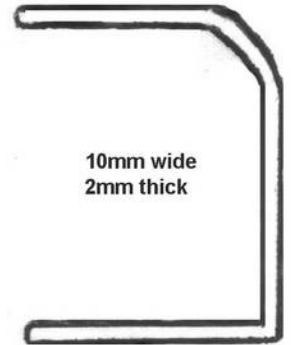

## Feed ramp

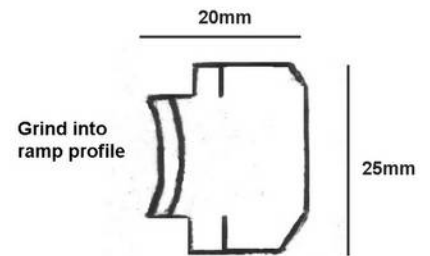

Attach to lower receiver using two m3 bolts through both sides

## Rear sight

48mm high / 25mm wide

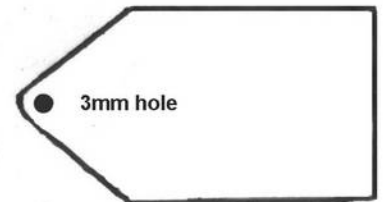

Position sight 15mm up from bottom of lower receiver - weld in place along sides

Lower receiver: 30mm x 50mm (2mm wall) mild steel box section  
 Rear sight & trigger guard: 14 gauge (2mm) mild steel sheet  
 Feed ramp: 1/4" (6mm) thick steel or aluminum plate



# Magazine well

Side  
43mm

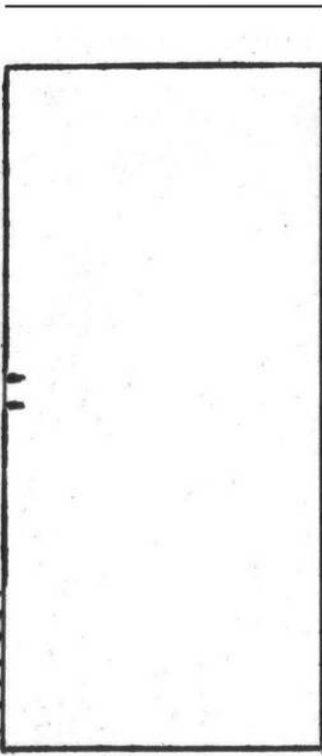

Catch housing is cut from 15 x 15 square tube or bent from sheet steel - weld in place

25mm

10mm

Back  
27mm

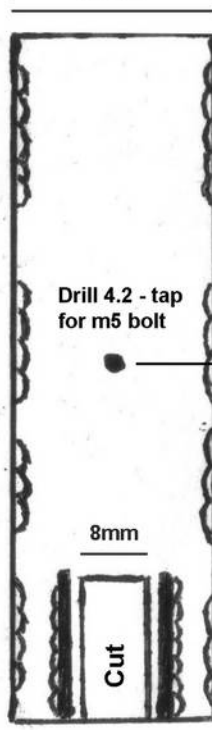

90mm

Drill 4.2 - tap for m5 bolt

8mm

Cut

15mm

A simpler alternative magazine well can be made from a length of 40 x 20 x 2mm tube to accept a homemade magazine made from 35 x 15 tube

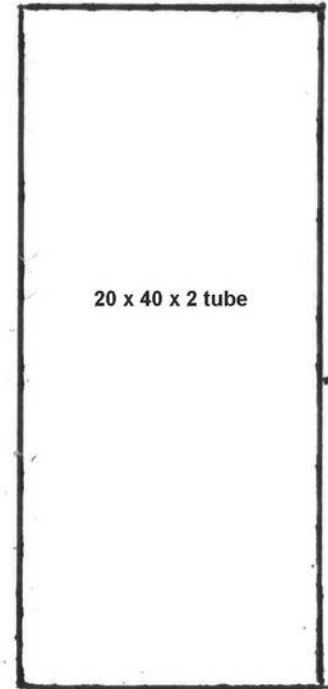

20 x 40 x 2 tube

Weld or bolt in place

A catch can be made from a portion of handsaw blade fitted with a bolt and two nuts ground to shape



The magazine well is created by removing a 1" side from a length of 1" x 2" steel box section after which it is widened out slightly to accept a sten magazine. The removed portion of wall is then welded back into place to form the correct inner dimension.

## Mag catch



A small compression spring rests behind this point

Secure with 15mm long pin

## Grip

1" thick wood or plastic

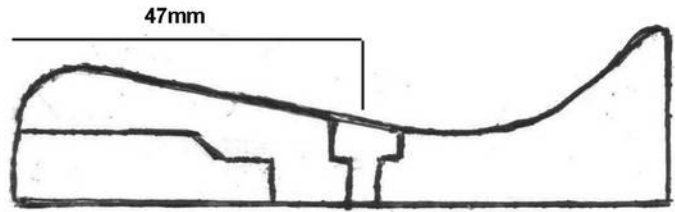

20mm wide, 10mm deep catch housing recess

90mm

2 inches

Print on 8.5x11 US letter paper

Sten magazine well : 1" x 2" (50 x 25 x 1.5mm) steel box section  
 Catch housing : 16 gauge (1.5mm) sheet or suitable steel box section  
 Magazine catch : 3/8" (10mm) steel or aluminum plate

# Bolt

## Bolt carrier

Cut from a 129mm length of 20mm x 20mm (2mm wall) steel box tube  
Cut out lower wall

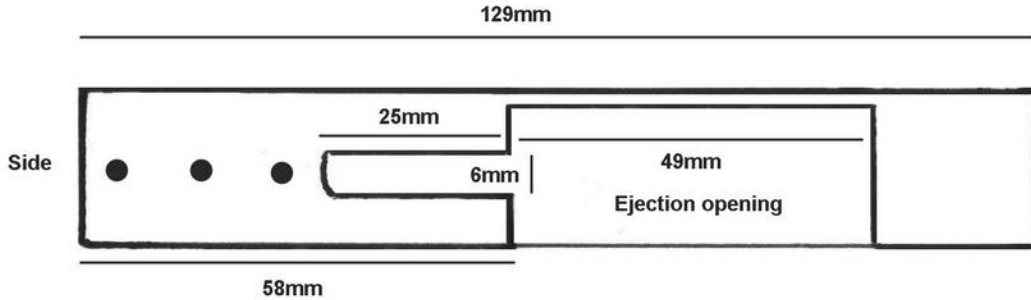

Leave 5mm of lower wall material on front edges to ensure positive contact with sear

Mount bolt piece using three 6mm mild steel bars or weld in place

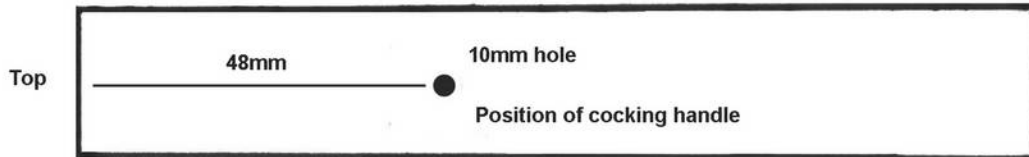

## Bolt handle

Modified m10 bolt (grind down upper 5mm)



Alternatively tap bolt carrier to accept an unmodified m6 bolt

## Bolt piece

Cut from a 58mm length of 5/8" (16mm) steel bar stock



- Drill center with 10mm drill bit until 3mm deep
- Grind flat with 10mm drill bit with tip removed using angle grinder
- Bevel edges slightly with 16mm+ drill bit or dremel

## Finished bolt face profile

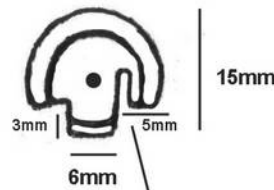

Grind feeding cuts using angle grinder fitted with 2mm grinding disc for entire 58mm length.

Cut ejection slot using angle grinder fitted with 1mm slitting disc until 7mm deep. Widen if necessary.

## Extractor

Bend from 28mm long strip of 5mm wide steel (2mm thick) to profile below

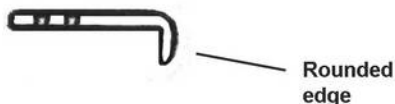

Drill out a 3/8" wide section of the bolt and add five 3oz tungsten 'pinocar derby weights' for maximum bolt weight - weld at rear

2 inches

# Trigger group & ejector

Cut trigger and sear from 10mm thick aluminum or steel plate

## Trigger

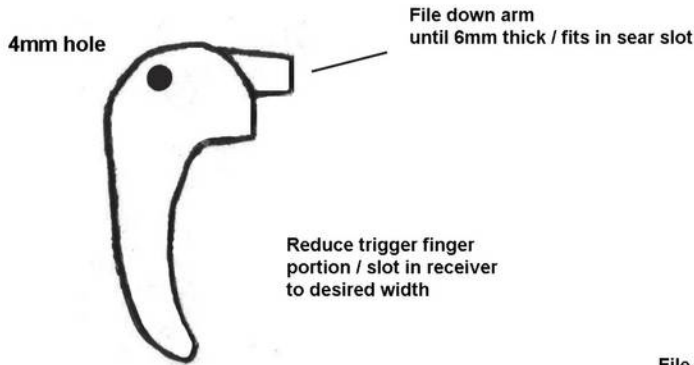

## Sear

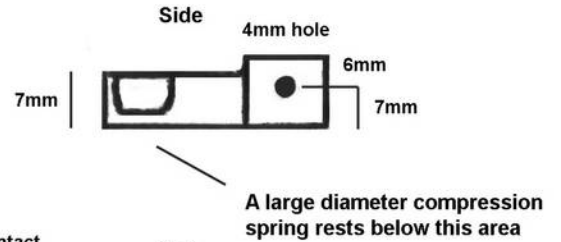

File down trigger contact point until ramp profile

## Top

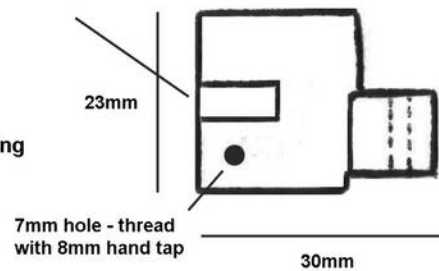

Sear tooth can be tapped into either side or both - hand fit until smooth functioning

## Finished trigger group

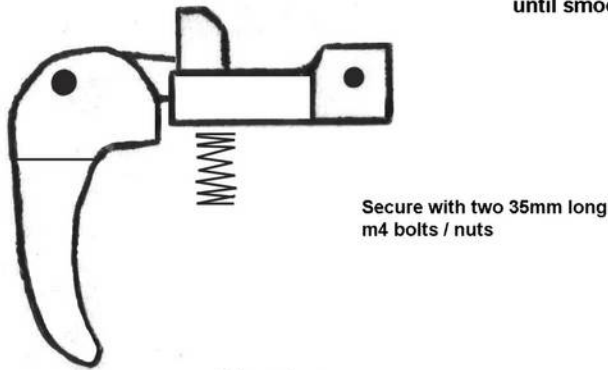

Tap hole with m8 bolt for sear tooth - cut off excess and grind to required profile

## Ejector

### Side

25mm

### Front

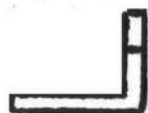
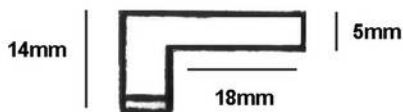

Bend from 2mm steel sheet

## Finished ejector profile

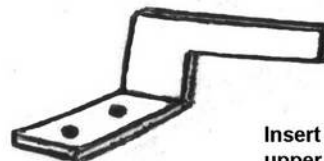

Insert into ejector slot on upper receiver - Bolt or weld in place

2 inches

Print on 8.5x11 US letter paper

Trigger and sear: 10mm thick aluminum or steel plate  
Ejector: 14 gauge (2mm) thick mild steel sheet

# Barrel and magazine

## Barrel

(Non-functioning dummy)

135mm



## Sling / hand strap mount

Weld in place or attach via circlip

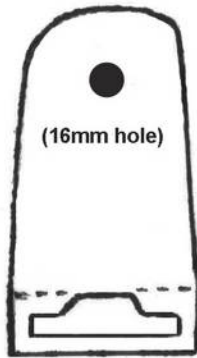

## Follower

Bend from 90mm long 10mm wide metal strip

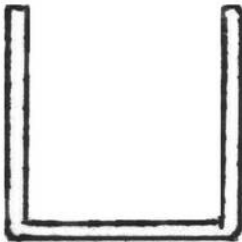

File to ramp shape

## Homebuilt magazine

35mm x 15mm tube  
7" long

111mm

Bend lips inwards until 9mm across

Cut 6mm

Secure with 2 pins and a 12mm x 32mm steel strip

90mm long, 12mm wide steel strip - bend and epoxy or silver solder in place

18mm long section of 5mm steel bar or bolt - epoxy or silver solder into rib

Wind 20 gauge spring steel wire around a 15" long 24mm x 8mm bar to form magazine spring.

- Leave 15mm between each turn until 12" in length.

## STEN magazine modifications

116mm (New mag-stop placement)

Remove stop tabs

2 inches

## .32 ACP / .380 magazine

Rather than hand winding a magazine spring, a 12mm wide, 2.5" long tension spring can be stretched out to form a very long compression spring suitable for use in such a small ID magazine.

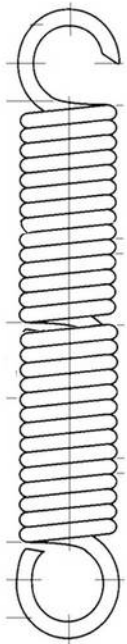

Hold both ends using pliers in each hand - stretch out until a consistent compression spring is formed. Snip both ends once complete.

A magazine spring produced in this manner will work reliably providing it is used in 30mm x 15mm tube sizes or smaller.

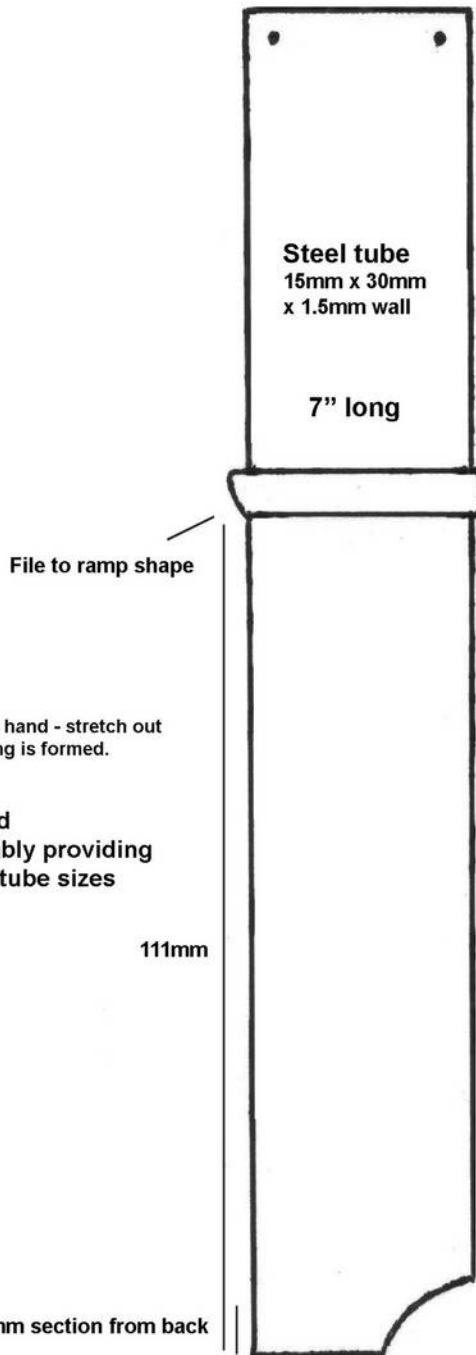

Base plate - 12mm x 27mm steel strip  
- secure with two pins

Weld or epoxy a 3" long, 4mm thick steel strip to the upper half of the back of the magazine tube to fit in a magazine-well made from 40mm x 20mm x 2mm tube.

Follower

Bend from 90mm long steel strip  
10mm wide x 2mm thick

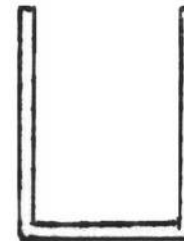

Cut away a 6mm section from back

Bend lips inwards evenly until both tips retain a cartridge  
- sand edges smooth

2 inches

You might also want to take a look at ...

