

THE MAC-10

CONSTRUCTION GUIDE

Practical Scrap Metal Small Arms **Vol.6**



By Professor Parabellum

The MAC-10 Construction Guide

Practical Scrap Metal Small Arms Vol.6



Plans on pages 10 to 22



Introduction

Detailed herein are plans for a 1:1 copy of the MAC-10 submachine gun, the only differences being the internals having been simplified for ease of home manufacture. For readers familiar with The Box Tube MAC-11 design described in Vol.2 & 5, the construction techniques and tools used in this project are very similar. The design described here is slightly less expedient, though what results is a highly accurate reproduction of the original weapon which will match many factory made examples in quality if care is taken. As before, no lathe or milling machine is needed and only very basic tools are required for construction.

*For legal reasons, the demonstration model pictured was built as a non-firing dummy replica. It contains a permanently destroyed dummy barrel which is welded in place, drilled and blocked with several hardened steel inserts as well as it's bolt having no provisions for a firing pin. **This document is intended purely for academic study purposes only.***

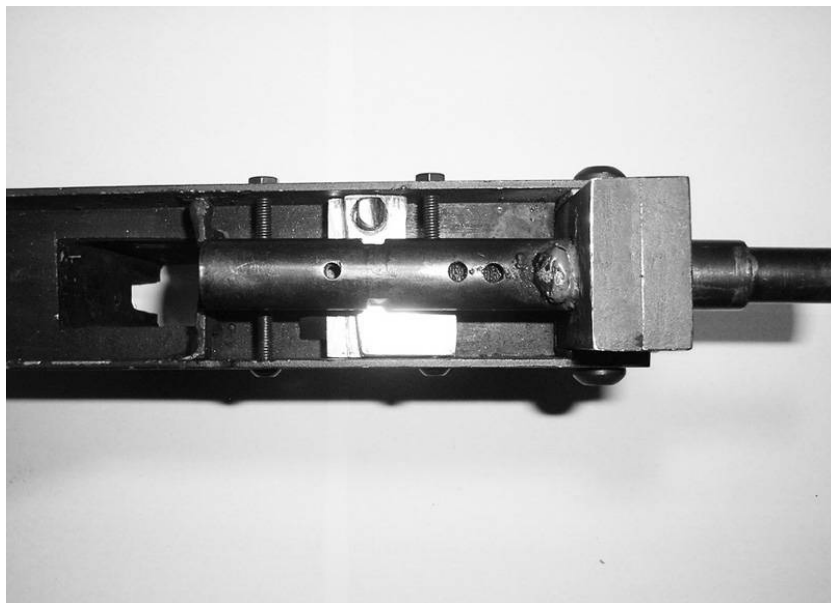

Destroyed dummy barrel of demonstration model

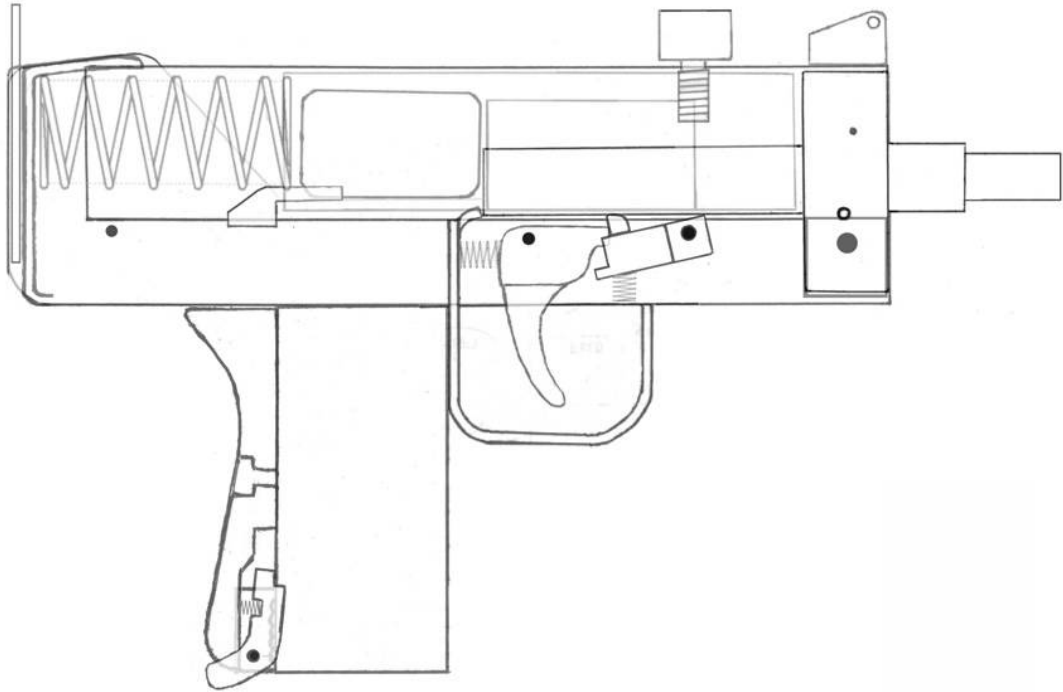

Useful Tools

Angle grinder
Hacksaw + cobalt tipped blades
Cobalt or titanium tipped drill bits
Drill press or hand drill combined with a stand
Welder
Dremel / rotary tool + reinforced cutting discs
Hand files

Materials

2mm or 2.5mm thick mild steel plate
38mm x 38mm x 1.5mm steel box section
1" x 2" (25mm x 50mm) steel box section
30mm x 30mm x 2mm steel box section
1" (25mm) mild steel bar
10mm aluminum plate
5/8" (16mm) steel bar or tube

Overview of components and their construction

Lower receiver



The lower receiver is constructed of plates cut from 2mm or 2.5mm steel sheet. It consists of a lower plate, bent twice at the rear to form a closure with two plates welded to either side. The lower plate has cuts made into it to accommodate passage of the magazine and trigger. Once welded together, four holes are drilled through each side plate. The trigger guard / feed ramp combination is cut out from a strip of steel sheet after which it is bent to the specified dimensions and welded in place.

Upper receiver



The upper receiver is simply a length of 38mm (1 1/2") aluminium or steel box section tubing with a wall thickness of 1.5mm (16 swg) into which the ejection port, cocking handle slot and lower opening are cut out using either a dremel type rotary tool fitted with a 'reinforced cutting disc' or by drilling a series of holes then chiselling the excess out before filing smooth.

Magazine-well

The magazine-well is made from a section of modified 1" x 2" (25mm x 50mm) steel box section, shortened to 25mm x 43mm by removing, slightly widening out, then re-welding on one side until able to accept a STEN magazine. The magazine catch is cut out from 10mm thick aluminium plate, it's housing consisting of a small piece of bent sheet steel welded in place. The back grip piece is cut out from either wood or plastic and is drilled to attach it via a short m5 bolt threaded shallowly into the magazine-well.



Bolt carrier assembly

The bolt carrier is constructed from a length of 30mm steel square box section tube onto which both the sides and top are increased in outside diameter using 2mm steel plate welded in place to match each side's respective profile. The final dimension of the finished bolt carrier should be 34mm, which is the correct dimension for functioning inside the upper receiver.



Bolt piece



Inert dummy example containing no firing pin

The bolt piece is made from a 50mm long section of 1" diameter steel bar stock which is 'machined' to shape using a drill, hand files and a small angle grinder. If cutting to length from a longer piece of bar, a series of holes can be made along the desired point using a 3mm drill bit after which an angle grinder fitted with a 1mm cutting disc can be used to finish the cut without needing to resort to a hacksaw.

The breech face of the bolt is first drilled using a 10mm drill bit for 3mm deep, then levelled flat using the same drill bit but with the tip having been removed to create a flat grinding bit. The feeding cuts for the magazine are carefully formed using a small angle grinder fitted with a 3mm grinding disc then hand finished using a file. Finally, a slot is made to it's side which accommodates passage of the ejector, allowing a cartridge to be 'flicked' out of the ejection port. The extractor is cut out from 3mm steel plate and retained using a 3mm pin with a small spring providing tension. Once the bolt piece is finished it can be pinned inside the carrier using four m8 grub screws or steel bars along each side allowing any needed adjustments prior to optionally welding it in place.

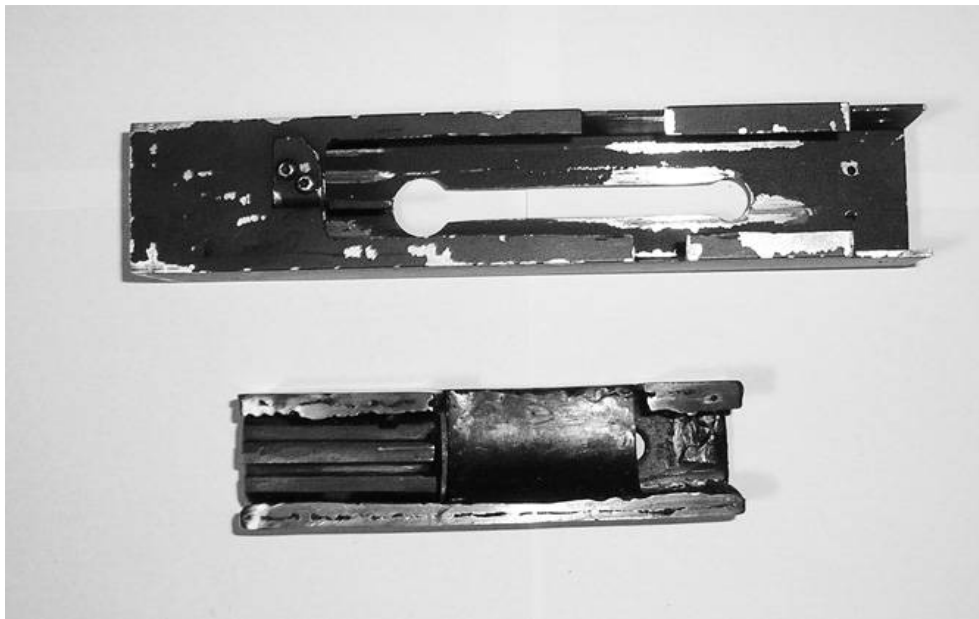

Finished bolt and upper receiver with ejector bolted to underside.



When assembled the bolt weighs almost 550g. If further weight is desired, a section of steel sheet can be welded to the inside of the carrier offering a convenient container for filling with more material and sealing with weld. The bolt piece itself can also be drilled with a 3/8" (9.5mm) bit to accept standard 3oz (85g) tungsten weights, each 12mm in length.

The cocking handle is made from an m10 bolt threaded into place, optionally modified in diameter using a ring of 19mm x 1.5mm tubing to improve ergonomics.

Trigger group



The trigger group is a very simple arrangement which allows the bolt to move forward under spring pressure when the trigger is pulled or stay cocked back behind the sear when the trigger is released. Both components are cut from 10mm thick aluminum (easier to cut) or steel plate. The contact surface of the sear is provided by way of an m8 bolt tapped into place which is then filed to it's correct shape. Compression springs which are ideal for use can usually be found by opening up the pump of a hand sanitizer or shampoo bottle.

Recoil Spring



A suitable recoil spring can be obtained from a lever type grease gun. The compression spring inside may need to be weakened by heating slightly and rapidly slamming to acquire the right amount of tension or by cutting off a number of coils. The spring used here measures 6.5" long, 30mm wide and is wound from 1.5mm diameter wire.

Finishing

High temperature engine enamel type sprays offer a very durable means of finishing each component and require little preparation and usually no priming. If used on aluminum, most spray finishes will not bond as reliably as they will on steel. Anodizing or parkarization may be employed if a higher quality finish is desired.

Plans

All pages included should be printed out on 8.5 x 11 US letter paper. Each component template is drawn to scale and can be cut out and glued to their respective thickness of material or used as reference for measurements. Make sure the ruler at the bottom left of each sheet is 2 inches in length. Alternatively, take a screen-shot and enlarge the plans using a computer program until the ruler is the correct length, then trace the parts needed onto a sheet of paper taped over your computer's screen.

Lower receiver templates

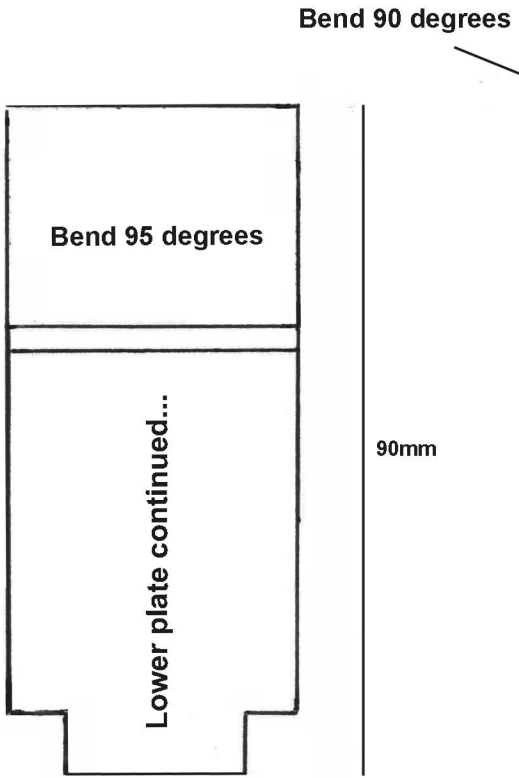

When cut from a single sheet of steel, the lower plate template should total 300mm in length before bending rear section.

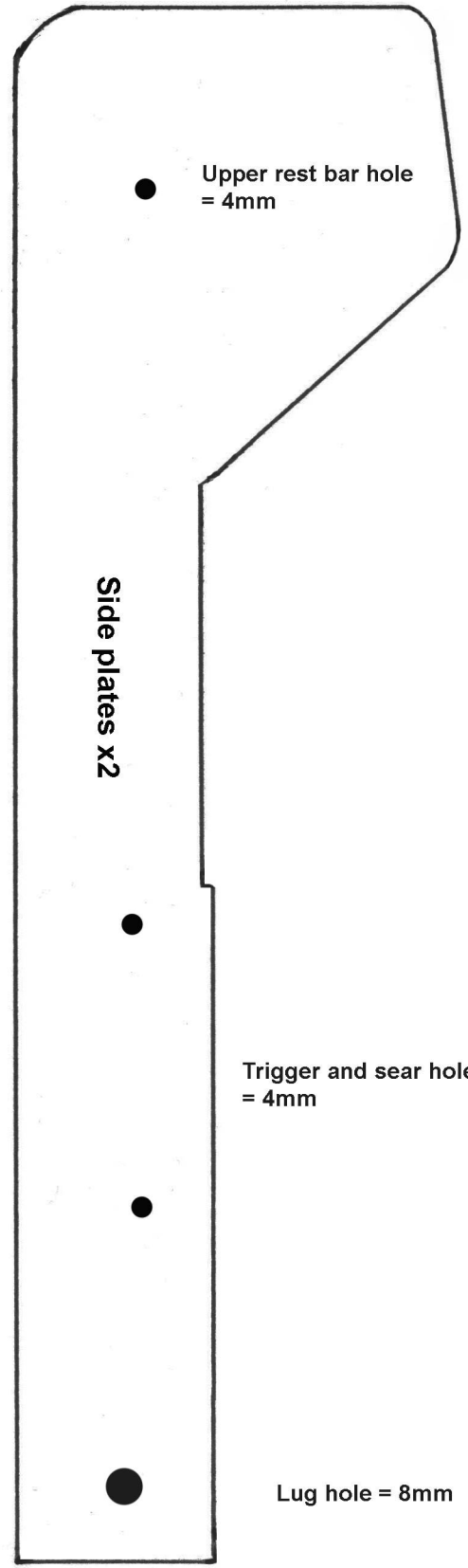
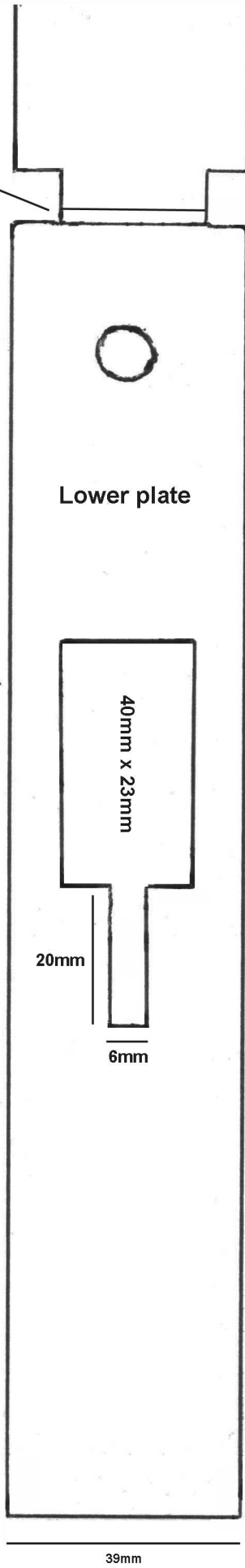

2 inches

Rear assembly

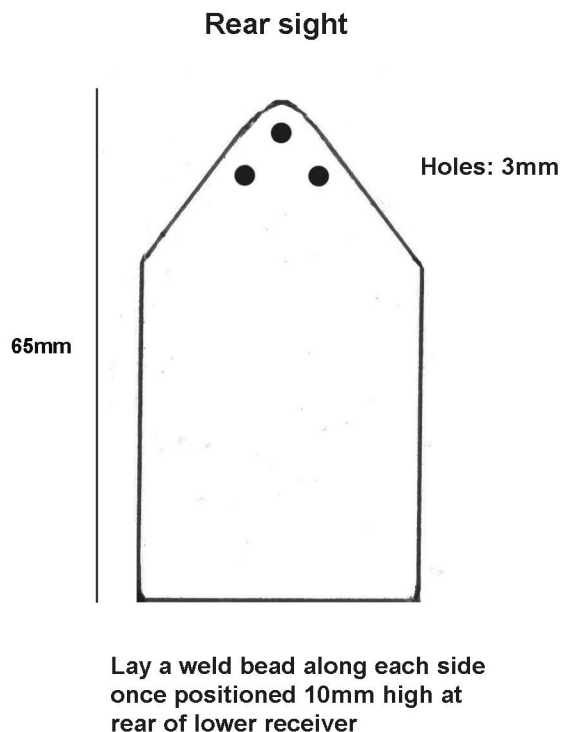
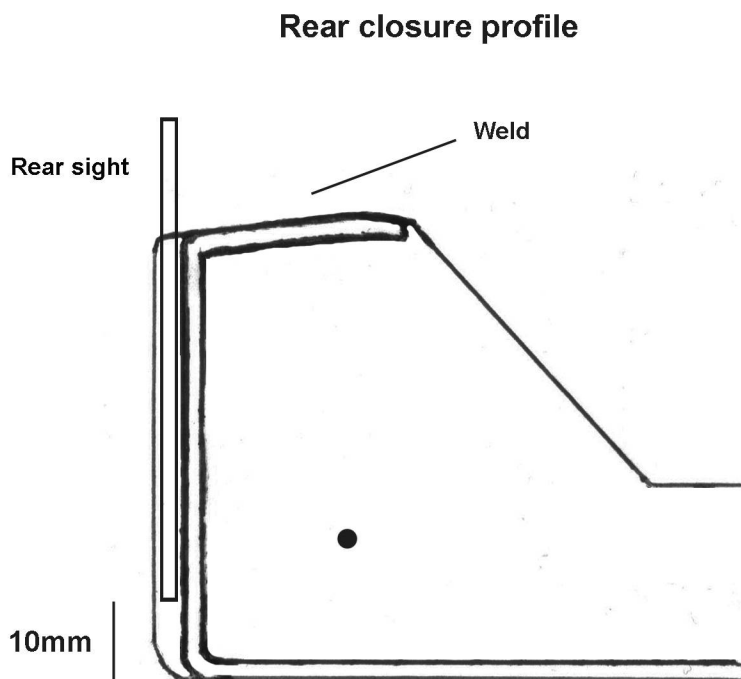

Welding lower receiver plates together

Position side plates and lower plate together using clamps, leaving a slight 'trench' between contact points to allow for adequate weld build up. A section of 38mm box tubing can be used as a jig.

Pointing down, lay a continuous weld beld along each side. Grind off excess weld and smooth over using an angle grinder fitted with a 3mm grinding disc.

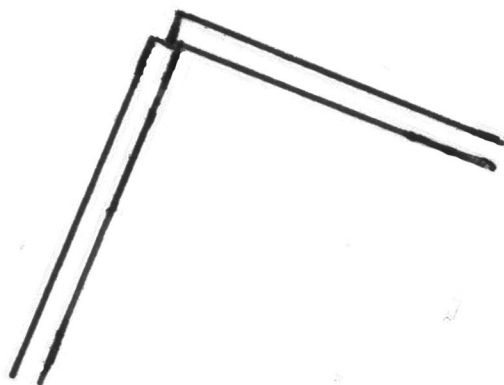

2 inches

Trigger guard / feed ramp

Template

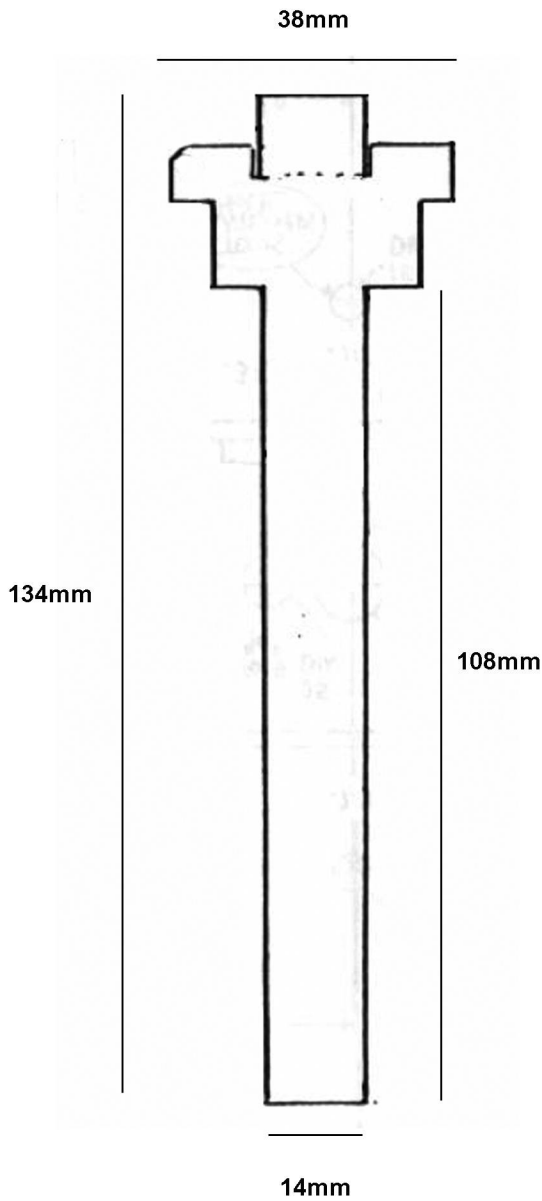

Finished profile

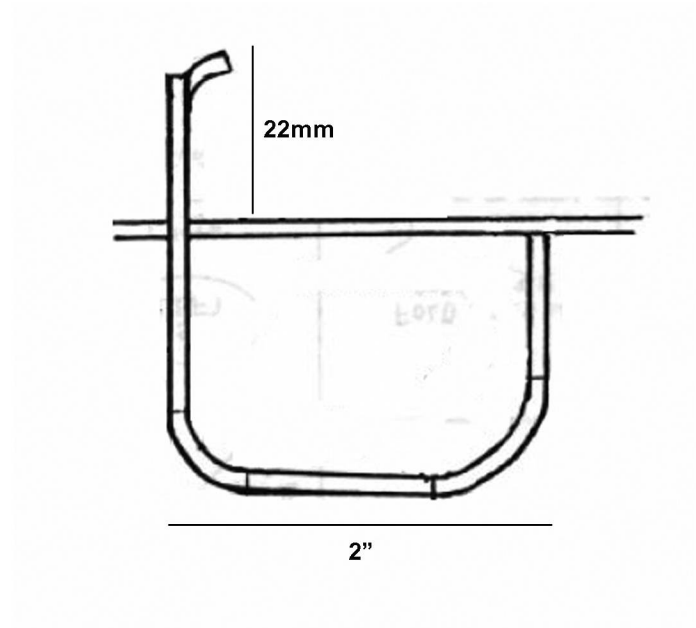

2 inches

Magazine-well

The Magazine-well is created by removing a 1" side from a length of 1" x 2" steel box section, after which the back is widened out slightly to accept a STEN magazine. The removed portion of wall is then welded back into place forming the correct inner dimension.

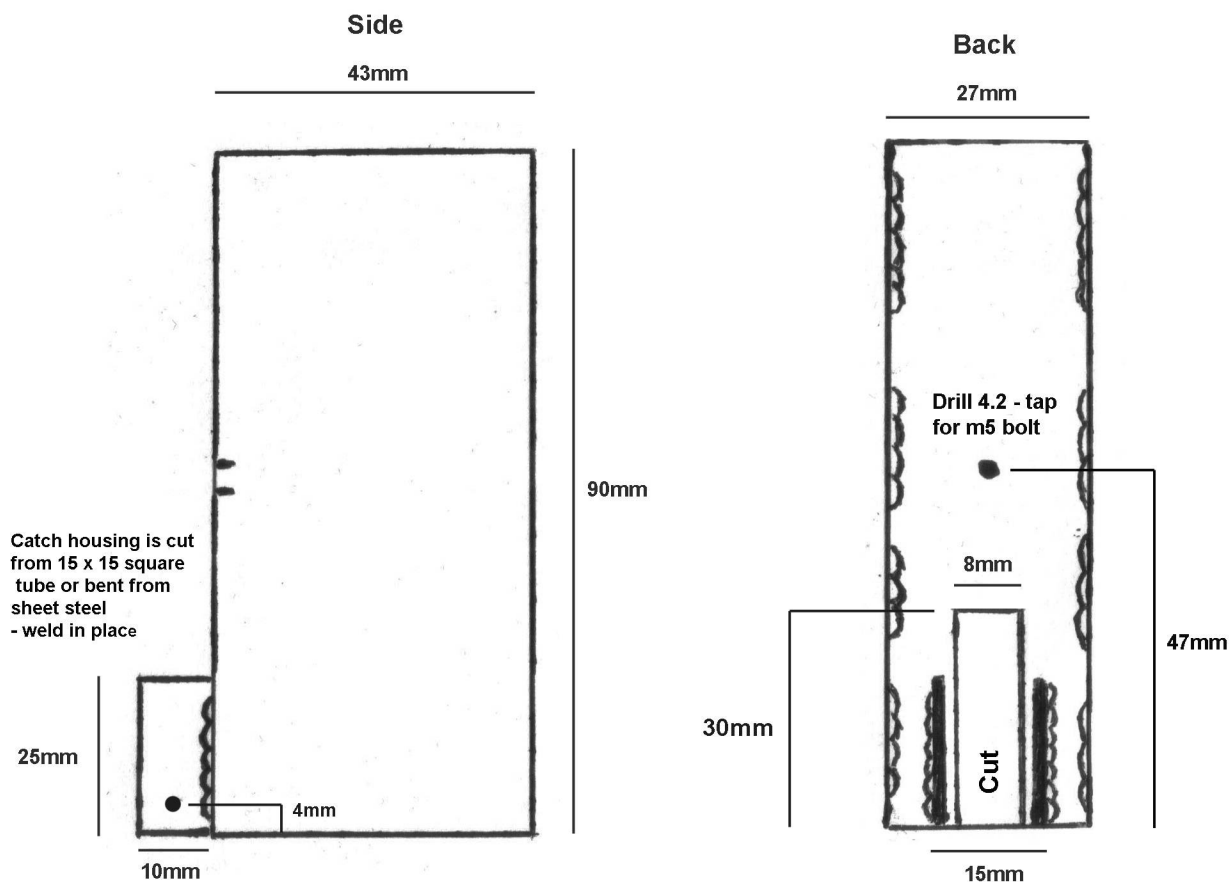

Mag catch

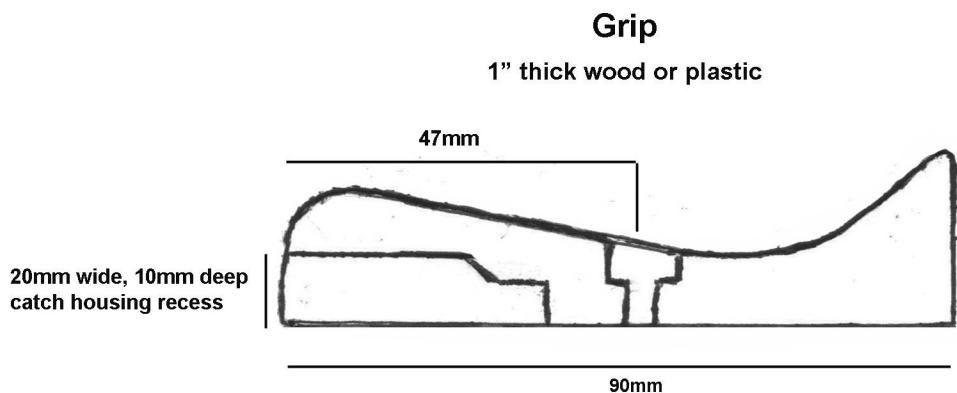

2 inches

Upper Receiver

Right side

198mm

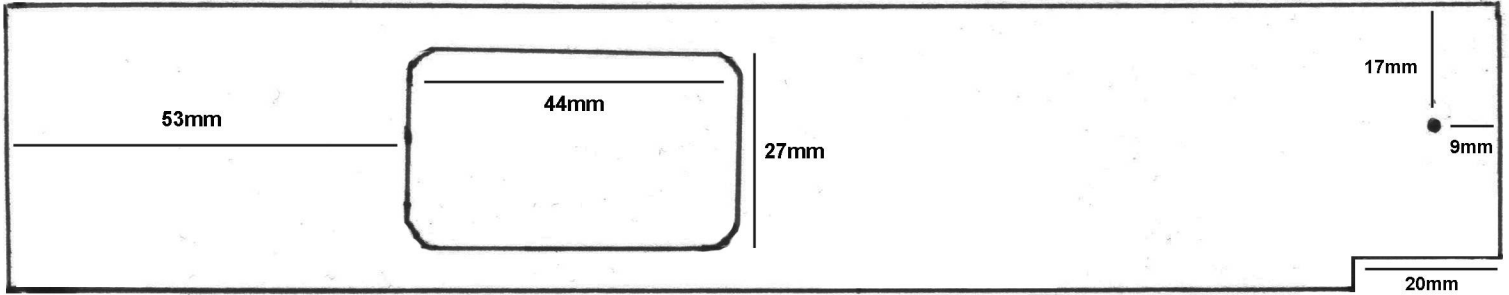

Top

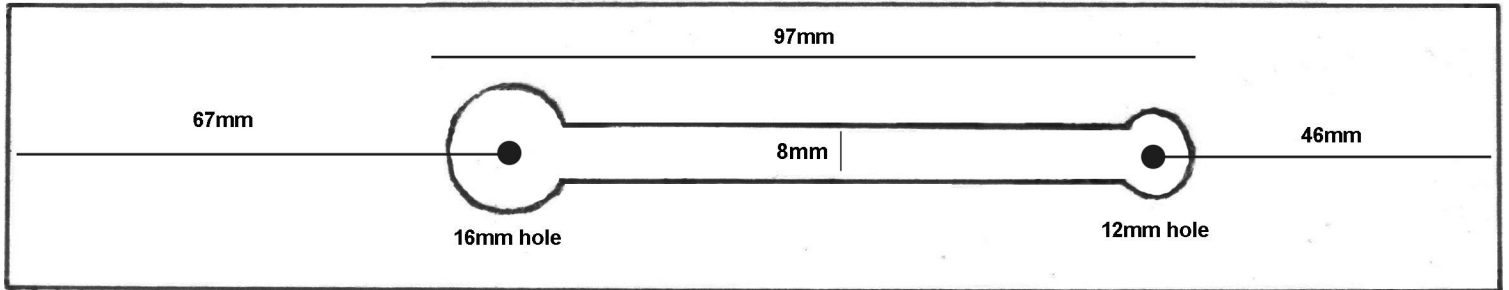

Left side

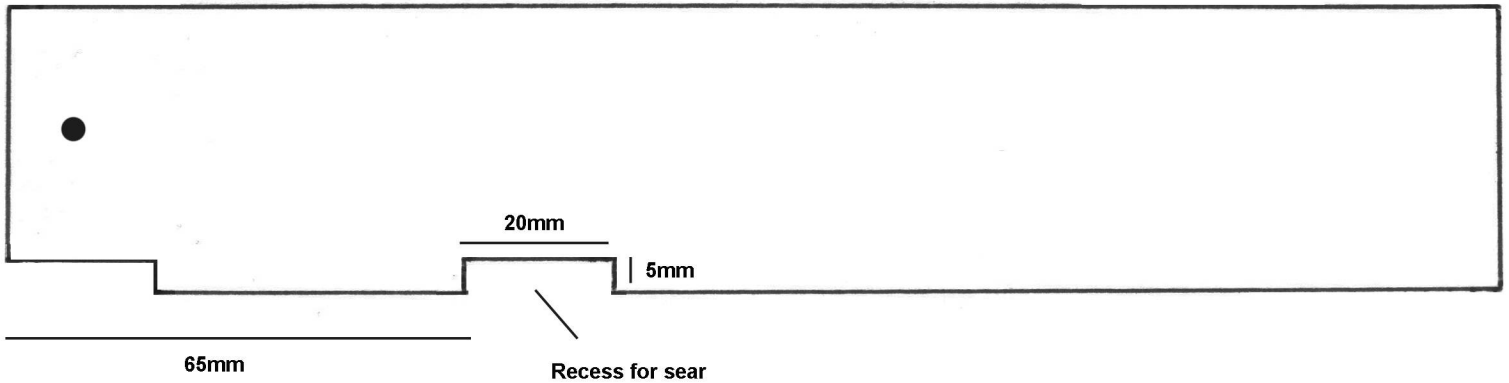

2 inches

Upper receiver

Bottom

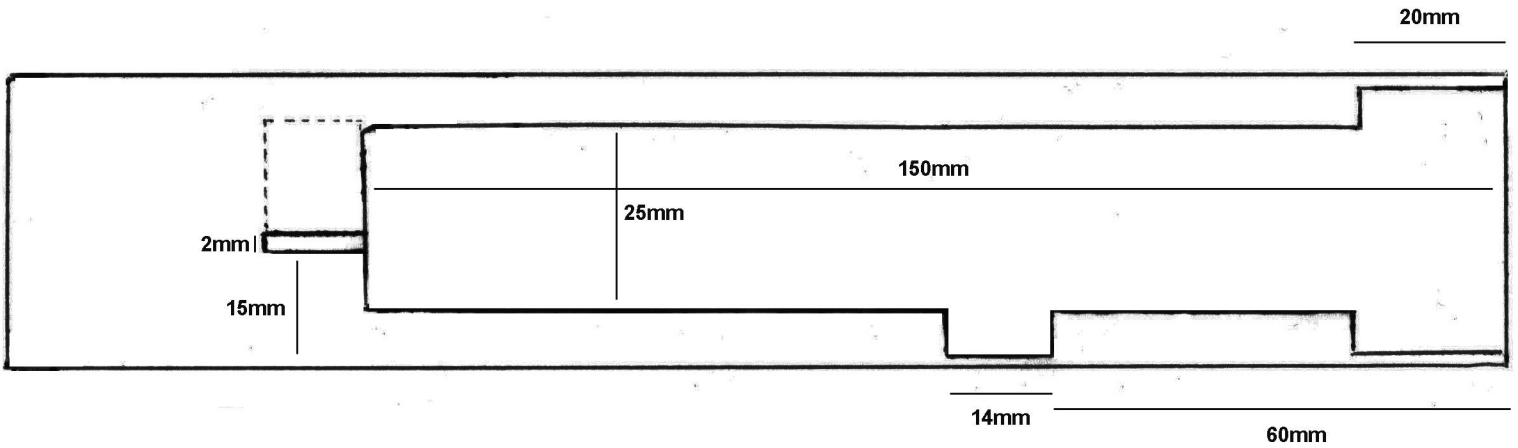

Front sight

Modify from a section of 25mm box tubing or bend from 2mm steel sheet

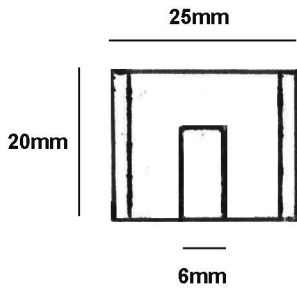

Slot middle and raise until 12mm high to form sight blade

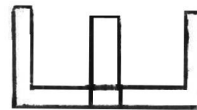
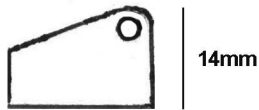

Ejector

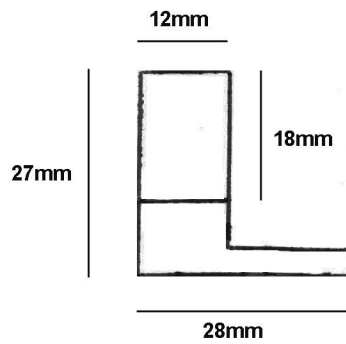

Finished profile

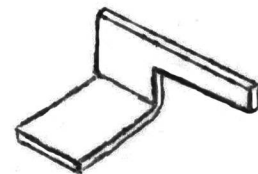

Secure through receiver slot using two bolts or weld

2 inches

Trigger group

Assembled:

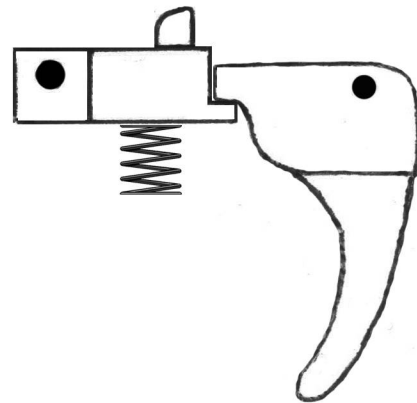
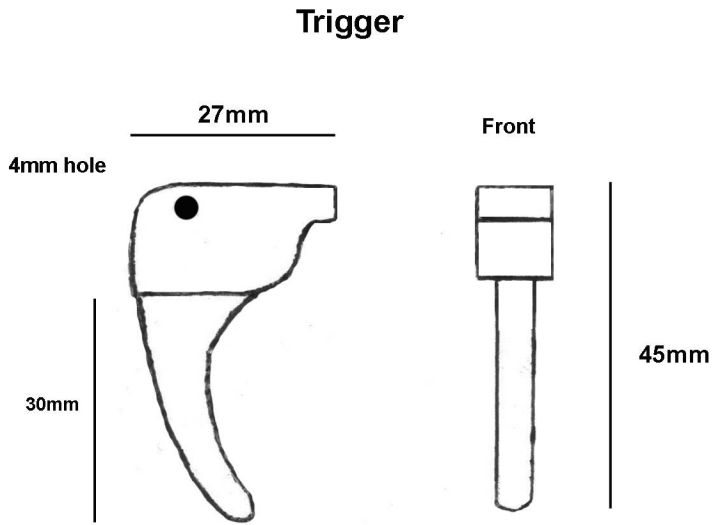

Sear

Drill sear tooth hole 7mm and tap for an m8 bolt. Cut off bolt so protuding 5mm high and file to shape to create sear tooth.

Top

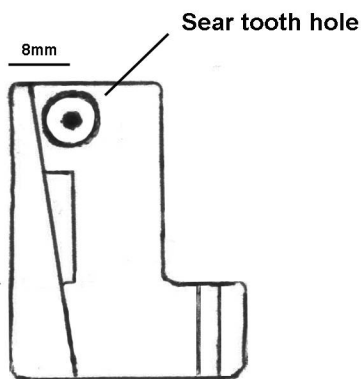

File down area for trigger to contact

Front

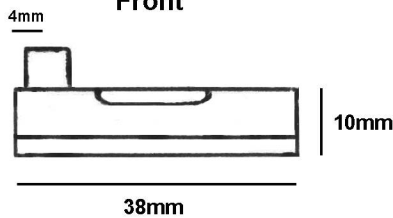

Side

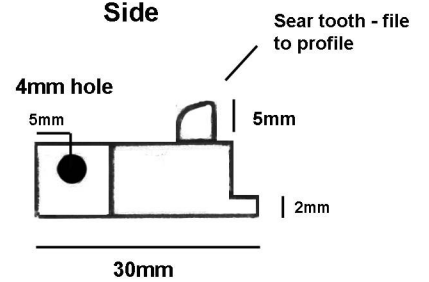

2 inches

Print on 8.5x11 US letter paper

Trigger and sear : 10mm thick aluminum plate
Sear tooth : M8 bolt

Bolt carrier

Inner bolt carrier - 30mm x 30mm x 2mm box section

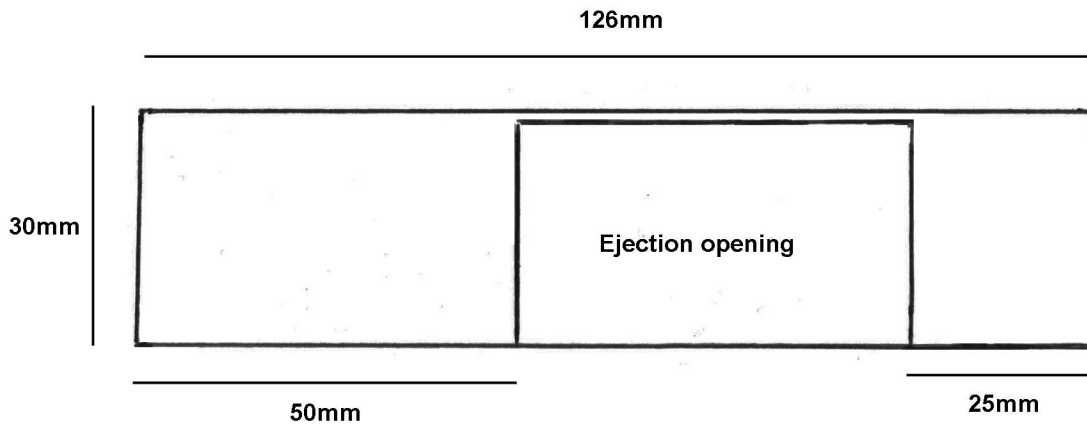

Side plates x 2
(Left side plate has no ejection opening)

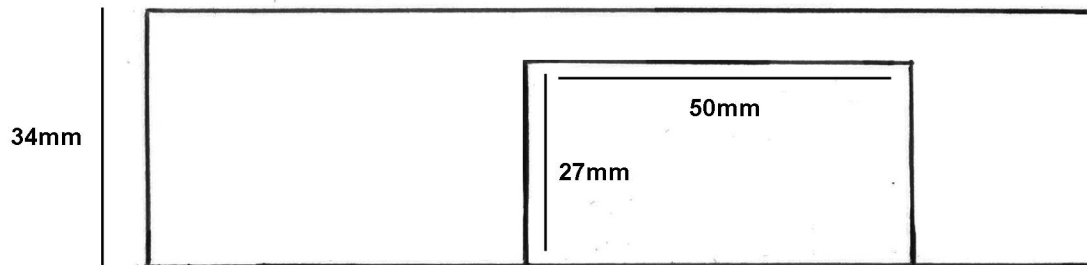

Top plate

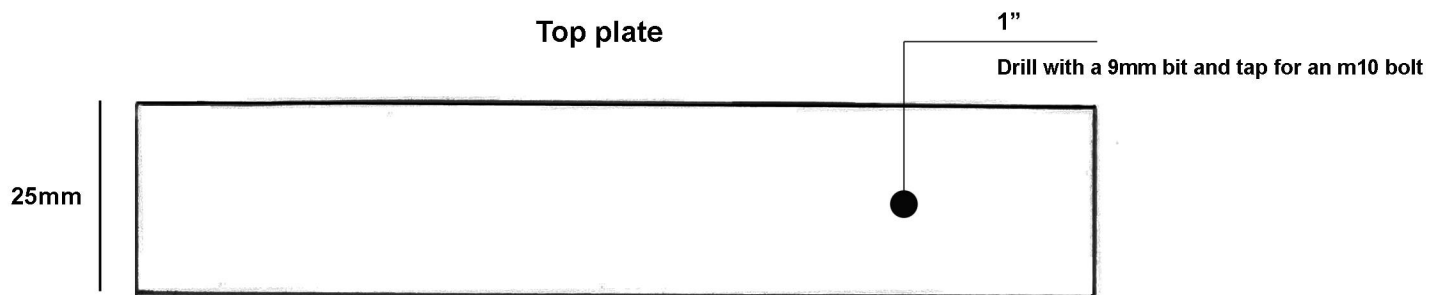

2 inches

Bolt piece

50mm long 1" dia mild steel bar

Breech face

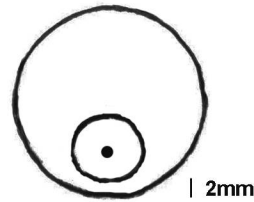
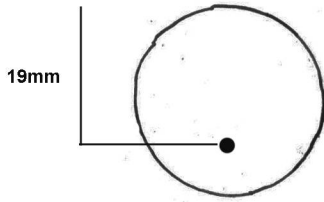

Mark a point 19mm below top. Drill with a 10mm drill bit for 3mm deep and level off with a beheaded 10mm bit to create a flat surface. Bevel edges slightly using a 16mm+ drill bit or dremel grinding tool. 2mm of material should remain below the hole to serve as a feed lip.

Completed:

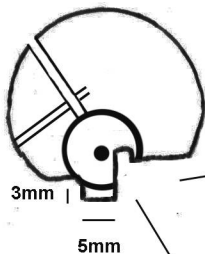

Grind down feeding cuts using an angle grinder fitted with a 2mm or 3mm grinding disc. Finish with a hand file.

Slit 5mm deep using an angle grinder fitted with a 1mm slitting disc. Widen with dremel if necessary.

Bottom

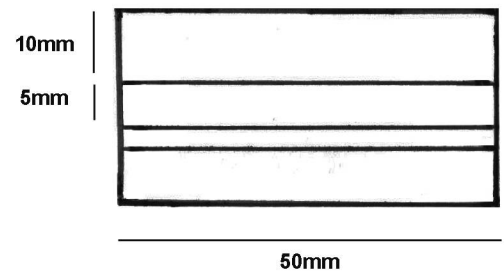

Extractor



Hand fit using a cartridge as a guide. Position extractor pin hole on bolt 11mm from front. Drill a 5mm hole to accept it's spring 25mm from front.

- Heat until cherry red and quench in motor oil to make-shift harden.

2 inches

Bolt (assembled)

Weld in place or secure bolt piece inside carrier using three or more 34mm long 8mm dia steel bars or three m8 grub screws tapped into each side.

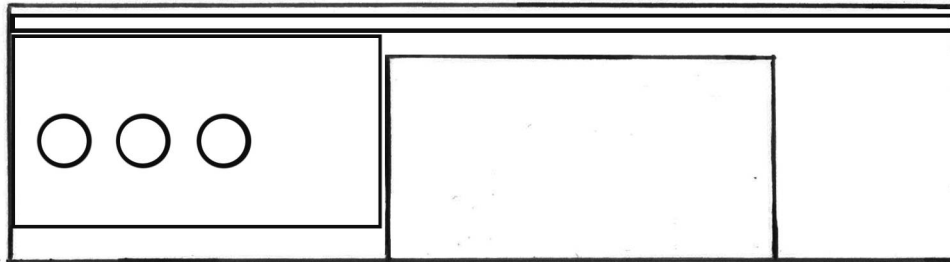

Weld top and side plates to inner tube along exposed edges. Grind excess weld smooth. Side plates should be positioned flush with bottom.

Bolt carrier front view:

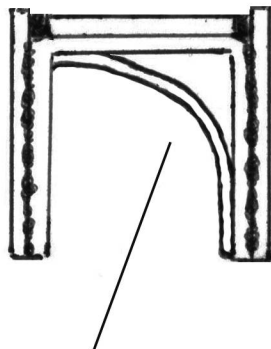

A 40mm x 50mm section of steel sheet can be bent and welded inside to hold additional weight behind it. This also acts as cocking handle depth stop.

- Alternatively a 10mm steel bar can be welded in it's place.

Cocking handle

15mm long m10 bolt

File down dia of top to 8mm wide to fit through cocking handle slot

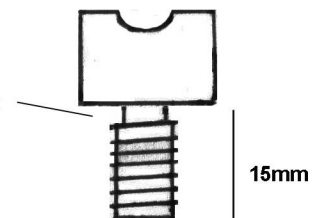

Secure a 12mm long section of 19mm x 1.5mm steel tube over bolt head using epoxy or silver solder. Slot top to allow function of sights.

Recoil spring:

- 6.5" long
- 30mm outer dia
- 1.5mm dia wire

A compression spring taken from a lever type grease gun should be suitable (May need to be shortened or weakened).

2 inches

Barrel assembly

Trunnion

20mm thick aluminum / steel block or two 10mm thick pieces bolted together

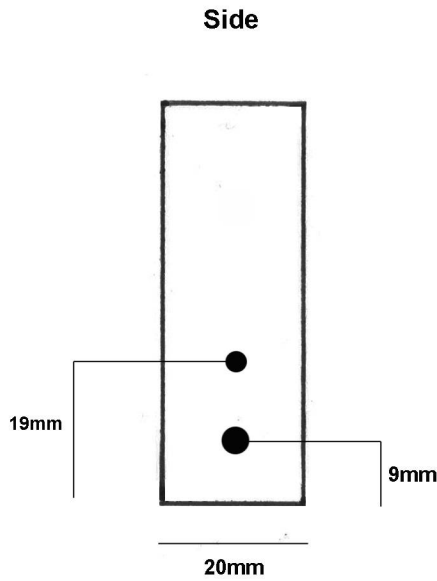
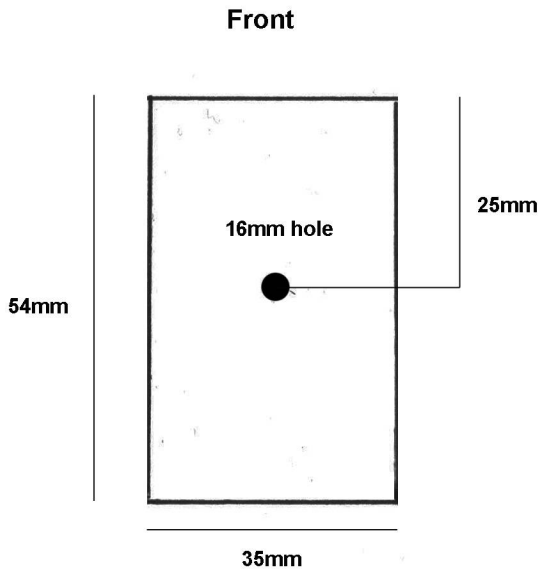

Sling / handstrap mount
(Secure with circlip)

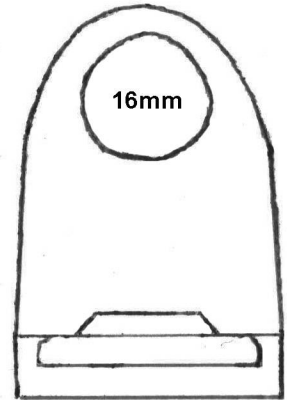

Sheet metal strip
20mm wide, 1.5mm thick

(Weld into front of lower receiver)

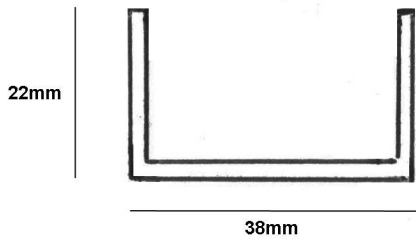

Barrel (dummy)

196mm long, 16mm (5/8") wide

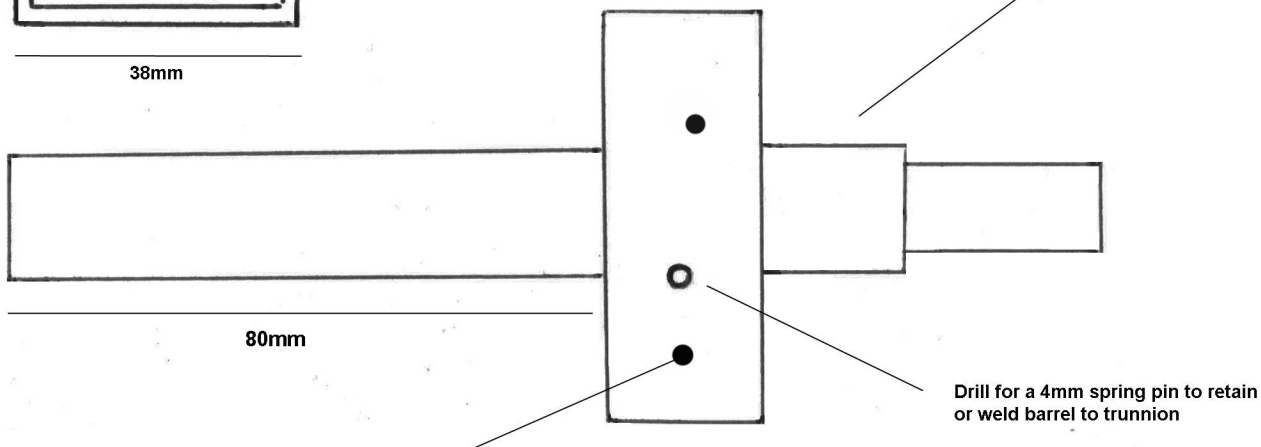

Position in lower receiver before drilling and tapping for an m8 bolt each side

2 inches

Print on 8.5x11 US letter paper

Trunnion : 20mm aluminum or steel block
Handstrap mount : 2mm mild steel sheet
Dummy barrel : 16mm bar or tube

STEN magazine modifications

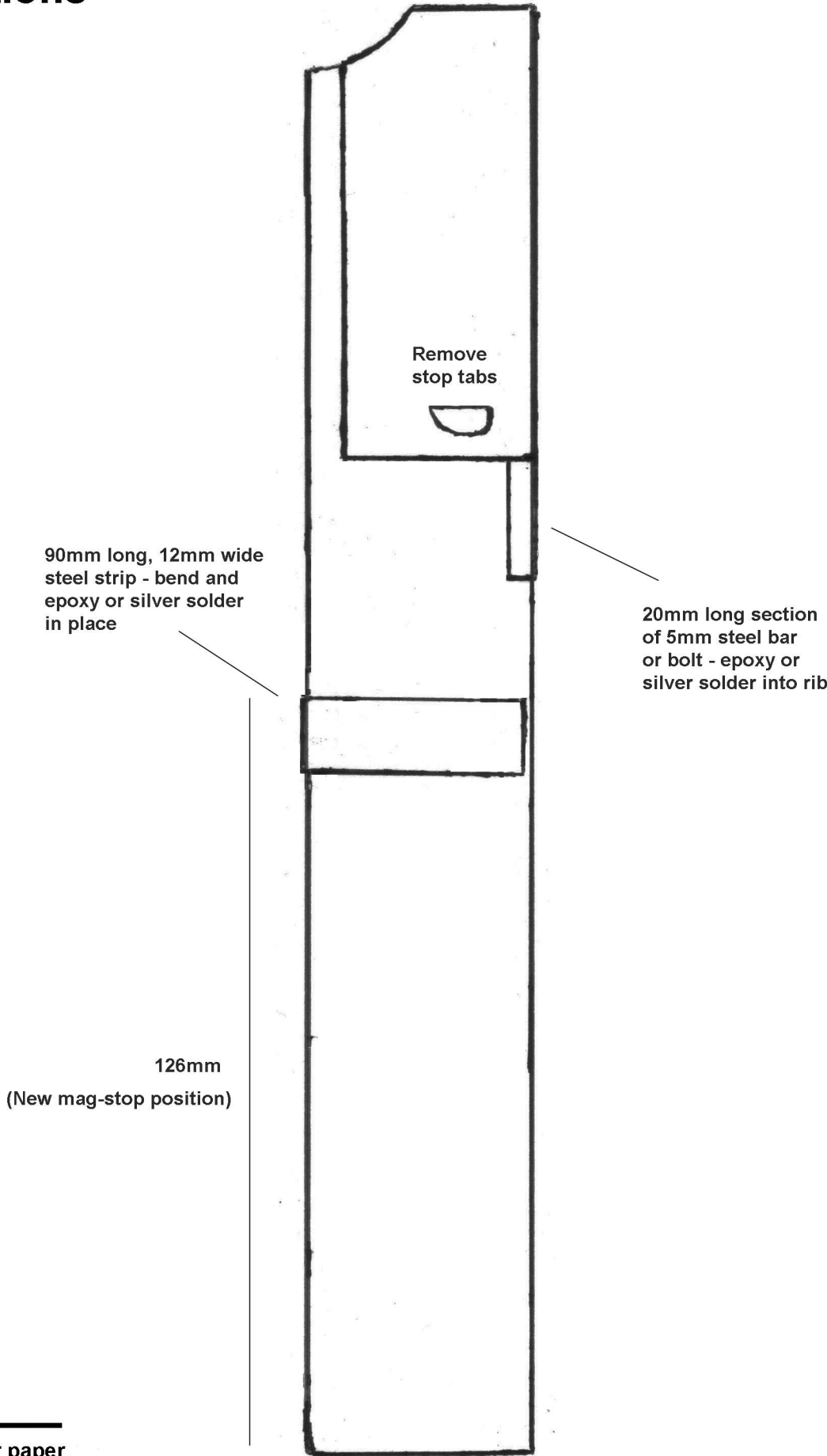

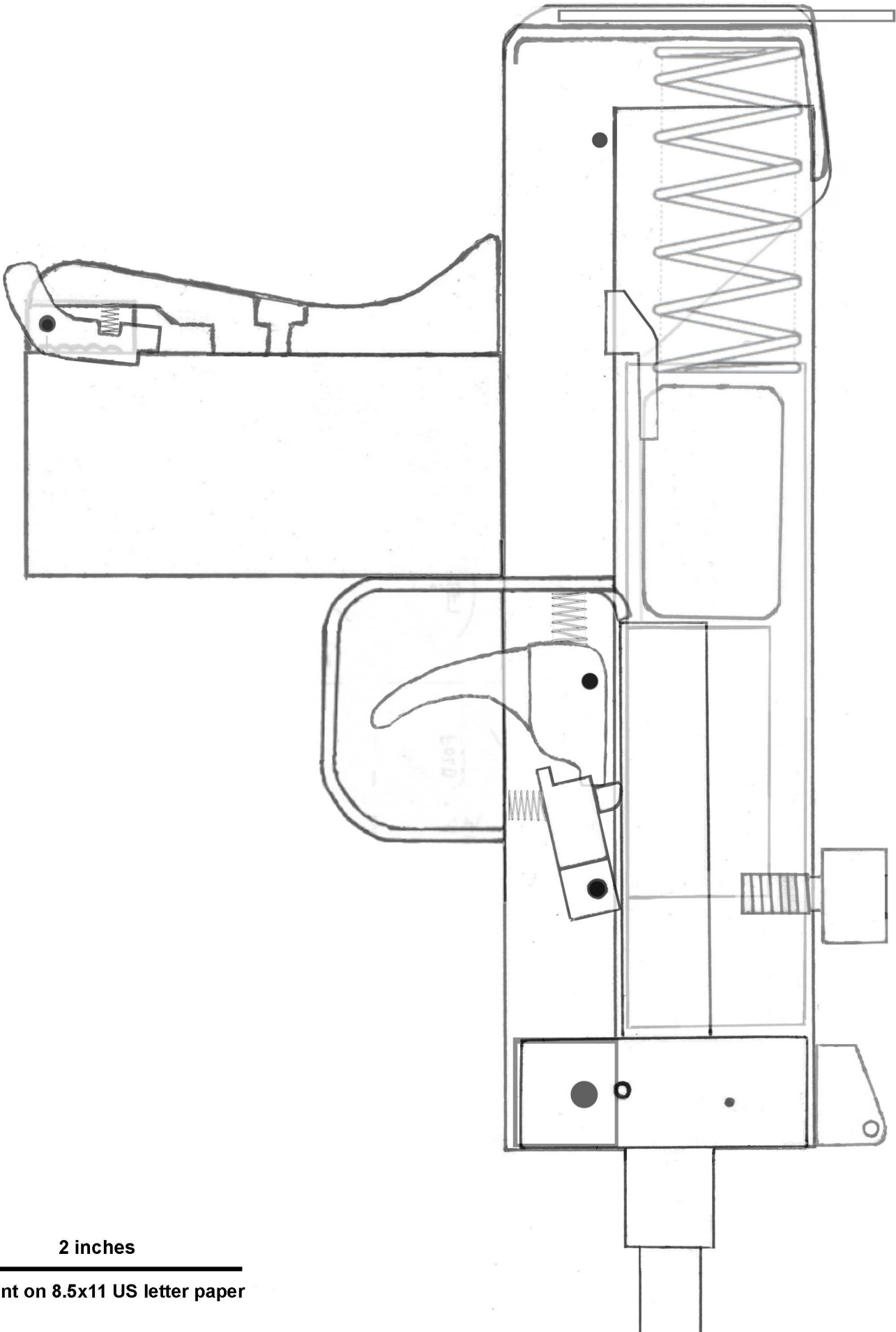

2 inches

Print on 8.5x11 US letter paper

Additional reads...

